

The FOBA COMBITUBE™ System. Simply practical.

**FOBA**®  
STUDIO-TECHNOLOGY

## FOBA: complete systems for photography

FOBA has supplied photographic shooting equipment\* for 70 years:

- World-class studio stands
- Tripods
- SUPERBALL® tripod heads
- ROOF-TRACK and MEGA-TRACK Ceiling Rail Systems
- Shooting tables
- Turntables for efficient 3D visualization
- Unroller devices for backgrounds
- Lamp stands
- COMBITUBE™ System, a kind of Meccano kit for all sorts of uses



**COKLO clamp in various production phases**

## Universal best references

FOBA products are used worldwide by reputed companies, public and educational institutions, museums and photographers.

**Most FOBA products are finished in reflex-free black.**

FOBA provides spare parts on a long-term basis.

Since most FOBA components are screwed in, defective parts can generally be replaced easily by the user.

## FOBA products are:

- modular, i.e. versatile
- interchangeable, i.e. can be upgraded at any time
- sturdy, i.e. have a long life span

These characteristics spell out high efficiency and usefulness. So investments in FOBA products are well worth their price.



# The FOBA COMBITUBE™ System. Simply practical.

## The FOBA COMBITUBE™ System has been proven and tested by professionals. Worldwide.

On the market since 1959, COMBITUBE™ has been put to hard work day after day by thousands of photographers – its success validates the unique concept and the ingenious underlying production philosophy. With its simple but effective logical concept, its handiness, the ease and speed of use, requiring neither tools nor additions, COMBITUBE™ amazes its users every day anew. The infinite variety of configurations that can be assembled with COMBITUBE™ components makes this system the most useful resource both for studio work and on location. A large range of accessories and its compatibility with most other FOBA systems make COMBITUBE™ even more attractive and indispensable for photographers.

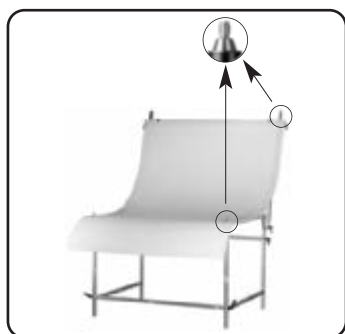

FOBA shooting table with integrated COMBITUBE connectors

## High interchangeability with FOBA products

COMBITUBE™ System components are logically compatible with most other FOBA products\*, e.g.:

- to extend FOBA tripods
- to replace pantographs on FOBA Ceiling Rail Systems
- as structures or additions on FOBA shooting tables
- together with FOBA articulated arms
- as convenient stands and supports for lamps
- as mobile unrollers for backgrounds, quickly and easily set up with COMBITUBE™

## 1001 combinations

Any type of rig can be set up ideally and quickly with the COMBITUBE™ System, whether to hold heavy equipment or for light, small and delicate objects.



## Designed for durability

The basic element is a black non-reflective aluminum tube, diameter 25 mm (approx. 1"). Available lengths are 6, 20, 40, 80 and 160 cm (2.4", 7.9", 15.7", 31.5", 63"). At both ends conical steel connectors, threaded or tapped, ensure stability and rigidity of the connections. COMBITUBE™ elements can be added together to reach any length. An ingenious concept, carefully selected materials and high-precision manufacturing underlie COMBITUBE's longevity and sturdiness. Tubes, threads and connections, etc. are designed to easily withstand the daily confrontation with exacting photographic work.

FOBA COMBITUBE™ elements are also available in nickel-plated silver colored steel.



## The FOBA COMBITUBE™ System consists of:

- COMBITUBES
- connectors
- supports
- fittings
- clamps and holders
- articulated arms
- holders for lamps and accessories
- other versatile elements

**FOBA COMBITUBE:  
for limitless  
creativity**

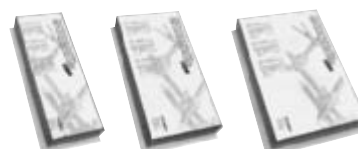

COMBITUBES and fittings are available in practical kits or individually.

\* For further information on the complete FOBA product range, visit [www.foba.com](http://www.foba.com)

# Some on-site applications of the COMBITUBE™ System

COMBITUBE™ in high-speed shooting action.



Shooting results

Dynamic COMBITUBE™:  
Car rig for full speed shootings.

Agile COMBITUBE™: Create exactly the camera support you need, wherever you want it.



Useful COMBITUBE™: How to shoot a hanging picture when there's no wall around.

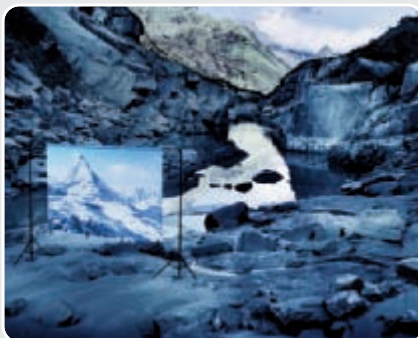

COMBITUBE™ setup for long-term outdoor use: photographic documentation of a large building site from beginning to end.



Extensible COMBITUBE™: No obstacle too high.



COMBITUBE™ for unlimited creativity.



Thanks to a great variety of components:  
the right solution for each situation

## Some studio applications of the COMBITUBE™ System

COMBITUBE™ – the system to grow with.



FOBA shooting tables are equipped with COMBITUBE™ connectors – create your own room-saving setups.



Precise lighting setup thanks to COMBITUBE™.



Lampstand or table, whatever the subject (here: jewelry) COMBITUBE™ enables quick solutions.



COMBITUBE™, all in one: ideal for mounting lamps, reflectors, and subjects as well.



Particularly in low-ceilinged studios, COMBITUBES are ideal to make the most of the available room height. Setting up lamps, screens, sails etc. is done quickly and without cluttering precious floor space.



COMBITUBE™, also ideal for displaying shooting results as holder:

- for projectors
- for magazines and brochures

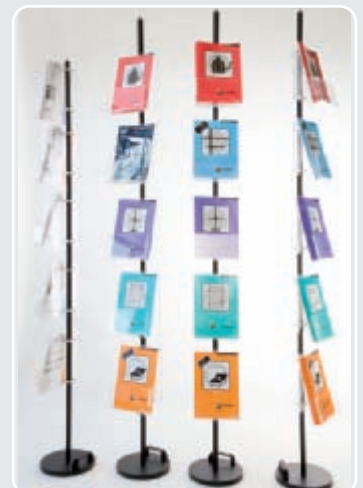

**COMBITUBE™:**  
no matter how complicated  
a shot is: this brilliant sys-  
tem is THE tool for it

It is amazing how many things you can do with just a few pieces of the FOBA COMBITUBE™ System.

**COMBITUBE™:**

- modular
- robust
- durable

**The heart of the system is the COMBITUBE.**

It can be extended at both ends by screw cone connection (e.g. CONRO AS).

**Unmatched versatility:**

The FOBA articulated connector holds COMBITUBES together at 52 different angles (COGEA).

**Ultra-useful:**  
The universal COMBITUBE clamp for holding cardboard, paper, textiles etc. – quick and reliable (COKLO).



**Unbeatable design:**

The gooseneck arm (COFLO / COFLU) and screw-on COMBITUBE clamp (COKLE) hold small objects in any desired position.



**More practical than ever:**

The hinged connector lets you add to existing structures without dismantling the rest (COTRI).



**Unequaled stability:**

The right-angle connector to attach another FOBA COMBITUBE at 90° (CODEA).



**Unsurpassed convenience:**

The cross connector for offset COMBITUBE jointing (CODIO).



## Three convenient kits make it easy to get started, with components selected by professionals for the professional.

The three kits are supplied in sturdy cases with firm compartments for convenient and safe transportation.

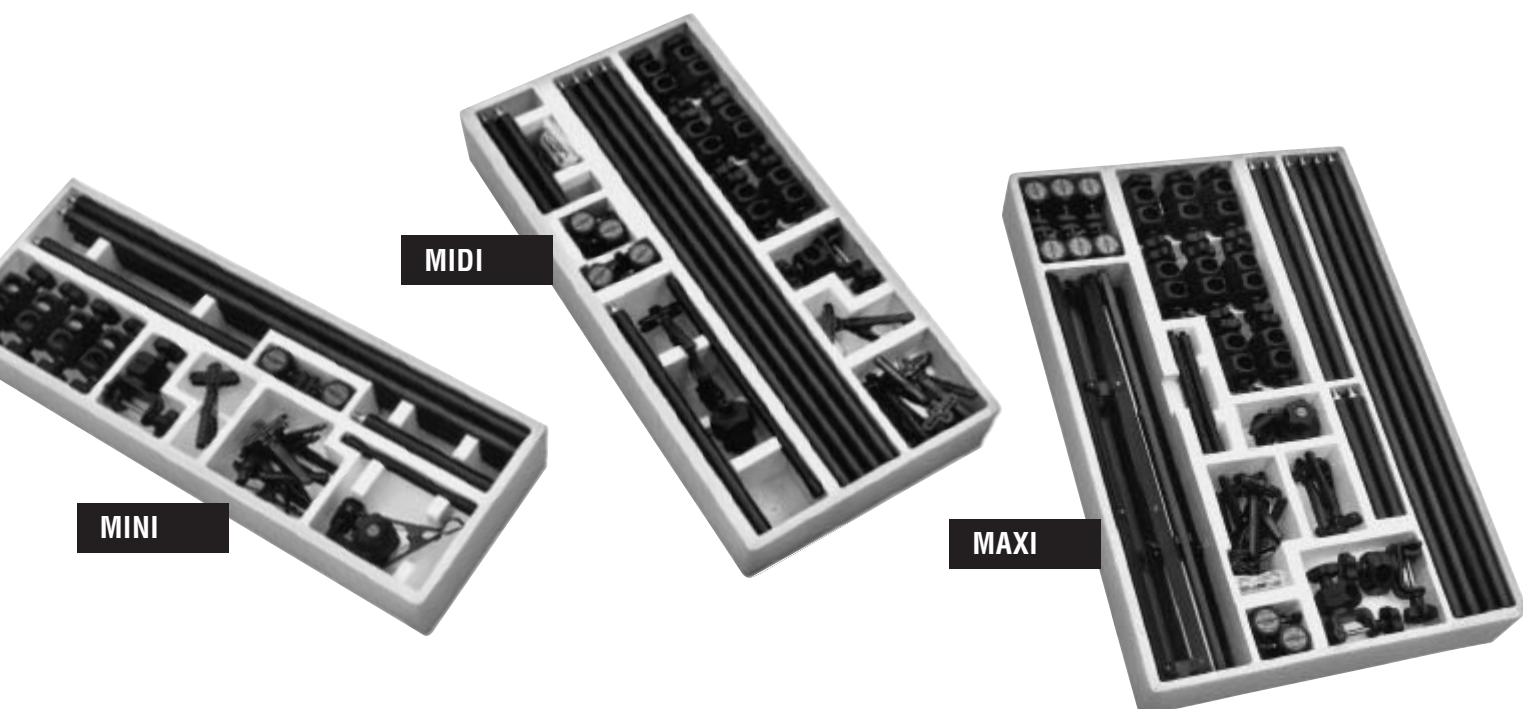

### FOBA COMBITUBE™ System MINI kit (CAMIN)

The smallest COMBITUBE™ kit is intended to satisfy the needs of static subject photography, and to provide a handy upgrade for FOBA shooting tables\*. It includes basic elements to suspend small objects, support paper backdrops and reflectors or secure subjects.

#### CAMIN consists of:

6	CONRO AS	COMBITUBE 80 cm, aluminium black
4	COKRO AS	COMBITUBE 40 cm, aluminium black
2	COARO AS	COMBITUBE 20 cm, aluminium black
2	COGEA	articulated connector, 7° steps, set of 2
2	CODEA	right-angle connector
1	COGAE	all-purpose screw clamp
1	COFLO	gooseneck arm, 20 cm
1	COKLE	COMBITUBE clamp, 3/8" tapped sleeve
1	COKLI	all-purpose joint with clamp
1	COKLO 5	COMBITUBE clamp, set of 5

Weight: 10 kg (22 lbs)

### FOBA COMBITUBE™ System MIDI kit (CAMID)

Just right for everyday applications in the studio or on location. The CAMID components are sufficient for set-ups with one or two shooting levels and corresponding background fixing.

#### CAMID consists of:

9	CONRO AS	COMBITUBE 80 cm, aluminium black
4	COKRO AS	COMBITUBE 40 cm, aluminium black
4	COARO AS	COMBITUBE 20 cm, aluminium black
3	COGEA	articulated connector, 7° steps, set of 2
2	CODEA	right-angle connector
2	CODIO	cross connector
1	COGAE	all-purpose screw clamp
1	COFLU	gooseneck arm, 40 cm
1	COKLE	COMBITUBE clamp, 3/8" tapped sleeve
1	COKLI	all-purpose joint with clamp
1	COKLO 5	COMBITUBE clamp, set of 5
2	COGUO	plastic foot, set of 2

Weight: 15 kg (33 lbs)

### FOBA COMBITUBE™ System MAXI kit (CAMAX)

CAMAX can be seen as basic equipment for demanding shoot setups, or as complementary to existing FOBA studio equipment. Special parts enable challenging configurations.

#### CAMAX consists of:

16	CONRO AS	COMBITUBE 80 cm, aluminium black
6	COKRO AS	COMBITUBE 40 cm, aluminium black
4	COARO AS	COMBITUBE 20 cm, aluminium black
4	COGEA	articulated connector, 7° steps, set of 2
6	CODEA	right-angle connector
2	CODIO	cross connector
2	COGAE	all-purpose screw clamp
2	COFLO	gooseneck arm, 20 cm
2	COKLE	COMBITUBE clamp, 3/8" tapped sleeve
1	COKLO 5	COMBITUBE clamp, set of 5
1	CEKLU	all-purpose joint for COMBITUBE
2	COSNO AS	folding tripod, alu, 65 cm
2	COGUO	plastic foot, set of 2

Weight: 21 kg (46.3 lbs)

\* For more information on the robust, colour-neutral and shadow-free FOBA shooting tables, see [www.foba.com](http://www.foba.com)

# COMBITUBE™

COMBITUBE steel or aluminium tubes have one male and one female connector (cone and 3/8" thread or tap). In theory, there is no limit to the length that can be reached by screwing COMBITUBES together. Aluminium tubes are anodized black, steel tubes are nickel-plated silver coloured.

Diameter: 25 mm (~ 1 inch). Five standard lengths are available:

		aluminium	steel
<b>COTMA</b>	6 cm (2.4")	COTMA AS	COTMA CL
<b>COARO</b>	20 cm (7.9")	COARO AS	COARO CL
<b>COKRO</b>	40 cm (15.7")	COKRO AS	COKRO CL
<b>CONRO</b>	80 cm (31.5")	CONRO AS	CONRO CL
<b>COKTO</b>	160 cm (63")	COKTO AS	COKTO CL

COTMA AS / COTMA CL

COARO AS / COARO CL

COKRO AS / COKRO CL

CONRO AS / CONRO CL

COKTO AS / COKTO CL

### COTMA AS / COTMA CL

COMBITUBE 6 cm long  
(connector not included)

Weight: COTMA AS 190 g (0.42 lbs)  
COTMA CL 220 g (0.49 lbs)

### COARO AS / COARO CL

COMBITUBE 20 cm long  
(connector not included)

Weight: COARO AS 230 g (0.51 lbs)  
COARO CL 300 g (0.66 lbs)

### COKRO AS / COKRO CL

COMBITUBE 40 cm long  
(connector not included)

Weight: COKRO AS 275 g (0.6 lbs)  
COKRO CL 410 g (0.9 lbs)

### CONRO AS / CONRO CL

COMBITUBE 80 cm long  
(connector not included)

Weight: CONRO AS 370 g (0.82 lbs)  
CONRO CL 580 g (1.28 lbs)

### COKTO AS / COKTO CL

COMBITUBE 160 cm long  
(connector not included)

Weight: COKTO AS 570 g (1.26 lbs)  
COKTO CL 1100 g (2.42 lbs)

**COMBITUBE™:**

- modular
- robust
- durable

### COTWE

Tube, 6 cm long, with two female COMBITUBE connectors. To connect two COMBITUBES in opposite directions.

Weight: 150 g (0.33 lbs)

### COTTO AS

Tube 6 cm long (connectors not included), with two male COMBITUBE connectors. To connect two COMBITUBES in opposite directions.

Weight: 230 g (0.5 lbs)



# Connectors

Close-up view: A strong clip spring clasps the 25 mm (1") diameter COMBITUBE almost all the way round, firmly and without damaging it.



## CODIO

Offset cross connector for 2 COMBITUBES.

Length: 6.5 cm (2.5")  
Weight: 195 g (0.43 lbs)

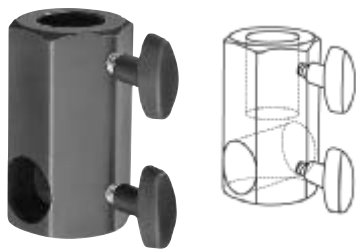
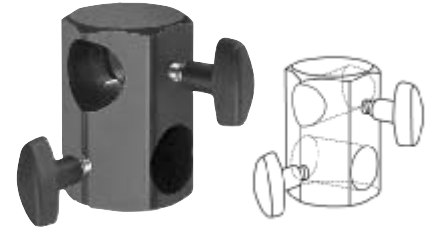

## CODEA

Right-angle connector, joins two COMBITUBES at 90° in the same plane.

Length: 7.8 cm (3.1")  
Weight: 250 g (0.55 lbs)

## COTRI

Hinged connector as right-angle connection, joins two COMBITUBES at 90° in the same plane.

Contrary to CODEA, this connector opens for trouble-free installation on existing structures.

Length: 8.1 cm (3.2")  
Weight: 250 g (0.55 lbs)



## COGEA

Articulated connector, to rotate two COMBITUBES relative to each other in 52 steps of approximately 7° over 360°. Equipped with a 52-step toothed ring. Set of 2.

Weight: 570 g (1.25 lbs)



The two halves of the COGEA articulated connector have different functions. The stationary COMBITUBE comes on the side with the red dot, which is the main clamping side. The second COMBITUBE comes into the other clamp and can then be pivoted in steps of 7°.

## COGEU

Articulated connector, precise 360° stepless positioning.

Length: 10.3 cm (4.1")  
Weight: 350 g (0.77 lbs)

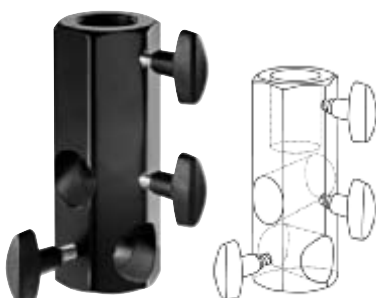

## COTRU

Triangle connector to join three COMBITUBES in different directions

Length: 11.5 cm (4.5")  
Weight: 360 g (0.79 lbs)

## COTRA

T-connector, to join 2 longitudinal COMBITUBES and a third perpendicular one.

Length: 12.2 cm (4.8")  
Weight: 410 g (0.9 lbs)

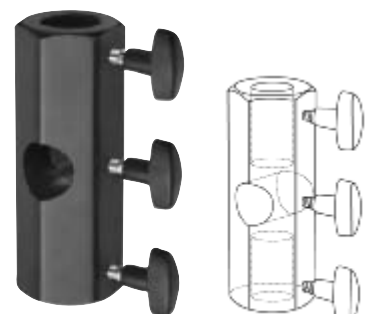

# Supports



## CESRA

Large and heavy round support, with male COMBITUBE connector. Protective felt underlay. With two M8 tapped holes. Handle included.

This support can be more practical than a tripod, because it has no legs to get in the way.

Diameter: 26 cm (10.2")  
 Height, w/o connector: 24 mm (0.94")  
 Weight: 9.5 kg (20.9 lbs)



## CIBAF

Middle size support with male COMBITUBE connector, three additional M6 taps. Fits CIBAM adapter or former GRAF articulated arms.

Particularly useful when little space is available, because several articulated arms can be mounted on the same support. Rubber knobs underneath.

Diameter: 17.5 cm (6.9")  
 Height, w/o connector: 20 mm (0.78")  
 Weight: 2.5 kg (5.5 lbs)



## CEBRO

Small support with male COMBITUBE connector; ideal for smaller set ups on tables, protective felt underlay.

Diameter: 12.5 cm (4.9")  
 Height w/o connector: 19 mm (0.75")  
 Weight: 1.1 kg (2.42 lbs)



## COSTO

Large folding tripod for COMBITUBE™ System, heavy-duty steel.

For tubes Ø: 25 mm (1")  
 Height folded: 95 cm (37.4")  
 Weight: 3 kg (6.6 lbs)



## COSNO AS

Small folding tripod for COMBITUBE™ System, lightweight aluminium.

For tubes Ø: 25 mm (1")  
 Height folded: 65 cm (25.6")  
 Weight: 760 g (1.7 lbs)



## CIBAM

Adapter with M6 thread and with COMBITUBE connector. The M6 thread fits the middle size support CIBAF.

Length w/o cone and thread: 30 mm (1.2")  
 Diameter: 25 mm (1")  
 Weight: 40 g (0.09 lbs)



## CESRO

Dolly, large model. For COMBITUBES (Ø 25 mm) and Ø 30 mm tubes (SANRO). Casters with brakes.

Occupies floor space corresponding to a 70 cm (27.6") equilateral triangle.

Height: 16.5 cm (6.5")  
 Caster Ø: 100 mm (3.9")  
 For tubes Ø: 25 mm (1") and 30 mm (1.2")  
 Weight: 21.5 kg (47.3 lbs)



## STARE

Small dolly, especially useful for placing lamps close to the floor and still be able to move them around. Includes RODEE 5/8" universal adapter.

Occupies floor space corresponding to a 42 cm (16.5") equilateral triangle. For Ø 25 mm uprights.

Height: 9.5 cm (3.74")  
 Caster Ø: 50 mm (1.97")  
 For tube Ø: 25 mm (1")  
 Weight (incl. RODEE): 4.8 kg (10.6 lbs)



## CESRU

Weighting plate for the CESRA large support or STARE small dolly to increase stability; with two M8 tapped holes for a handle.

Outside diameter: 26 cm (10.2")  
 Height: 24 mm (0.9")  
 Hole diameter: 26 mm (1")  
 Weight: 9.4 kg (20.7 lbs)



CESRO comes with an adapter sleeve; it takes both 30 mm and 25 mm diameter tubes.



Close-up of **STARE** dolly. A strong spring clip clasps the 25 mm dia. COMBITUBE almost all the way round without damaging it.



The CIBAF support with 3 gooseneck arms attached (partly with CIBAM adapter) enables a very space-saving arrangement of the microscope and two side lamps (held with COKLE clamps) around the subject (example of an industrial application)

# Fittings



**COBLA**  
COMBITUBE adapter for all normal gripheads.

Rod Ø: 16 mm (5/8")  
Length overall: 12 cm (4.7")  
Weight: 210 g (0.46 lbs)



COBLA:  
truly versatile



**COBLE**  
COMBITUBE adapter for all normal superclamps.

Length overall: 8 cm (3.1")  
Weight: 160 g (0.35 lbs)



COBLE:  
a valuable aid in  
all studios



**COBLI**  
COMBITUBE male connector for 5/8" lamp adapter.

Bottom hole Ø: 16 mm (5/8")  
Length without cone: 5 cm (2")  
Weight: 150 g (0.33 lbs)



Shown here:  
• COBLI, lamp adapter  
• CIBAO, articulated arm  
• COBLO 5, transition piece  
• Flag

COBLI lets every  
lampstand hold a  
lot more



**COBLU**  
Hinged COMBITUBE connector, Ø 5/8" (16 mm).  
Fits many lampstands, e.g. also on STAPI telescopic upright.  
Very tight clamp prevents the hinge from twisting.

Length: 6 cm (2.4")  
Hole Ø: 16 mm (5/8")  
Weight: 240 g (0.53 lbs)

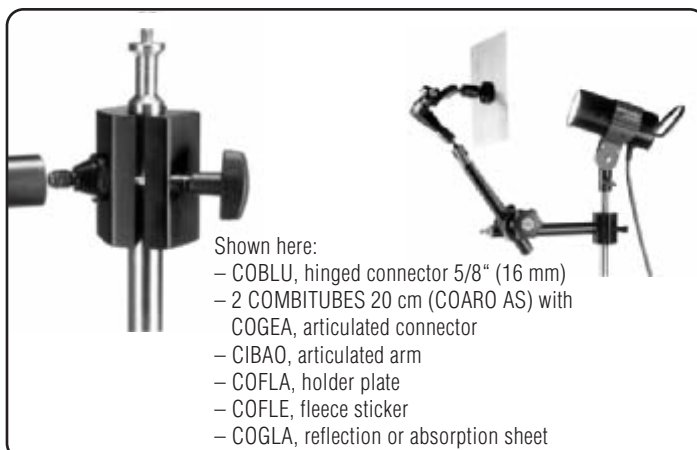

Shown here:  
– COBLU, hinged connector 5/8" (16 mm)  
– 2 COMBITUBES 20 cm (COARO AS) with  
COGEA, articulated connector  
– CIBAO, articulated arm  
– COFLA, holder plate  
– COFLE, fleece sticker  
– COGLA, reflection or absorption sheet

The COBLU  
hinged connector  
makes lamp-  
stands truly ver-  
satile

Always holds reflectors and light absorbers in exactly the right position.

## Fittings



### COGAE

All-purpose screw clamp to secure a COMBITUBE to a suitable surface or on a tube. Rotates in 7° steps.

Max. clamp aperture: 45 mm (1/8") for flat assemblies and for 40 mm (1/6") diameter tubes

Weight: 390 g (0.86 lbs)



The COGAE all-purpose screw clamp is a versatile help for holding COMBITUBE assemblies wherever you want, in the studio or on site.



### ASNEA CO

Screw clamp with two perpendicular male COMBITUBE connectors. Very robust. Can be fixed on a tube or a suitable surface.

Max. aperture: 73 mm (2.9") for flat assemblies and for 60 mm (2.4") diameter tubes

Weight: 810 g (1.8 lbs)

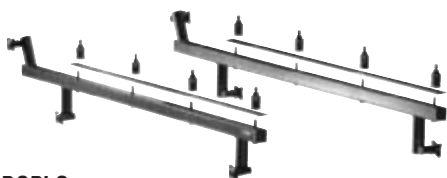

### DOPLO

Pair of 2 side brackets for **DIGRO** and **DIBRO** shooting tables\* or for large COMBITUBE assemblies, with 4 COMBITUBE connectors per bracket at the top and 2 below.

Length: 120 cm (47")

Weight: 6.6 kg (14.5 lbs)



### COGUO

Plastic foot for COMBITUBE, prevents slipping. Set of 2.

Inner Ø: 25 mm (1")

Weight: 15 g (0.03 lbs)



COMBITUBE end protector: COGUO plug-on plastic foot



### ASGME

Aluminium tip for COMBITUBE, as well as for FOBA tripods\* ALFAE and ASNIO. Increases COMBITUBE rig stability on natural surfaces, especially on location.

Thread: 3/8"

Length w/o thread: 4 cm (1.6")

Weight: 20 g (0.04 lbs)



### ASSME

Removable rubber cap for COMBITUBE tip ASGME. Prevents slipping and protects delicate floors.

Weight: 20 g (0.04 lbs)



COMBITUBE end closure:

- With screw-in ASGME tip and
- ASSME rubber cap



### COLRU

Separate caster for COMBITUBE. Makes COMBITUBE rigs mobile.

Maximum load: approx. 30 kg (66 lbs)

Additional height: approx. 10 cm (3.9")

Caster Ø: 50 mm (2")

Weight: 300 g (0.7 lbs)



### CARRI

Threaded mounting flange for fixing COMBITUBES to walls or ceilings, etc.

Overall width: 9.3 cm (3.7")

Weight: 120 g (0.26 lbs)

\* For more information on the robust, colour-neutral and shadow-free FOBA shooting tables, see [www.foba.com](http://www.foba.com)

\* For more information on FOBA's world-famous stands and tripods, visit [www.foba.com](http://www.foba.com)

# Fittings



## ASNIO

This agile mini tripod\* is extremely versatile:

- Its legs can be swung up more than 90°.
- Unlimited leg extension with COMBITUBES.
- Leg diameter fits the COMBITUBE™ System for easy connection to any COMBITUBE connector.

This flexibility makes shooting possible everywhere, however inaccessible.

With 3/8" and 1/4" camera screws.  
Height: variable with COMBITUBE components.

Min. height: 10 cm (3.9")  
Folded length: 30 cm (11.8")  
Max. load: 60 kg (132 lbs)  
Weight: 2.1 kg (4.6 lbs)



The ASNIO tripod: first-class for everyday shooting in tough conditions



With the COMBITUBE™ system, no obstacle is insurmountable. For greater stability, the tripod legs can be mutually strutted with further COMBITUBE components (here the ALFAE tripod), very useful above all for:

- Architecture photography
- Panorama shots, and
- Shots with long exposure times.



## ROTUO

Trolley with COMBITUBE connector, for the FOBA ROOF-TRACK Ceiling Rail System\*.

Suitable for 36 mm (1.4") rail width.  
Length: 15 cm (5.9")  
Weight: 440 g (1.0 lbs)

Trolleys with COMBITUBE connector are available also for the FOBA MEGA-TRACK\* Ceiling Rail System:

- RAGIE, twin-wheels trolley
- REGIE, trolley with wheel lock



Overhead lighting: lamp on **CEONO** sliding clamp with **CEONA** extension, hanging from a FOBA ROOF-TRACK Ceiling Rail System\*. A **CEGEE 25** safety ring at the bottom keeps the lamp from accidentally sliding off the COMBITUBE.

COMBITUBES and FOBA ceiling rails\* in combination are particularly useful in low-ceilinged studios, where they enable optimal use of limited space.

FOBA tripods\*:  
Ideal for all assignments...



... with ASSME removable rubber cap and ASGME metal tip.



... unlimited extension with COMBITUBE™ modular components.

\* For more information on FOBA's world-famous stands and tripods, visit [www.foba.com](http://www.foba.com)

## Clamps and holders



### COKLO

COMBITUBE clamp, extra strong, with holding hook in front. Essential for holding cardboard, paper, textiles, etc.

Length: 14.5 cm (5.7")  
Weight: 80 g (0.18 lbs)



### COKLO 5

COKLO COMBITUBE clamps, set of 5.

Weight: 400 g (0.88 lbs)



### COKLO 10

COKLO COMBITUBE clamps, set of 10.

Weight: 780 g (1.7 lbs)



### CIBAK

Clamp with non-rotating bolt connector, fits CIBAE articulated arm, CIBAL extension and CIBAP adapter or accordingly the Graf system.

Length: 16 cm (6.3")  
Weight: 120 g (0.26 lbs)



### CIBAL

Extension with non-rotating bolt connector at top and bottom. Fits CIBAE articulated arm, CIBAK clamp and CIBAP adapter or accordingly the Graf system.

Length: 20 cm (7.9")  
Diameter: 14 mm (0.55")  
Weight: 90 g (0.2 lbs)



### CIBAP

Adapter

- Top with non-rotating bolt connector for CIBAK clamp or CIBAL extension or for the Graf system

- Bottom with female COMBITUBE cone, fits articulated arms CEKLU, CIBAO, etc.

Length: 4.5 cm (1.8")  
Diameter: 25 mm (1")  
Weight: 50 g (0.11 lbs)



### COKLE

COMBITUBE clamp, tapped 3/8" to fasten onto COMBITUBE, gooseneck arms (COFLO, COFLU), articulated arms (CEKLU, CIBAO), tripod heads, etc.

Length: 14.5 cm (5.7")  
Weight: 90 g (0.2 lbs)



### COFLA

Holder plate with Velcro on one side and 3/8" tapping on the other side. Includes 8 fleece stickers (COFLE).

COFLA can be attached to goosenecks, articulated arms, tripod heads, COMBITUBES, etc. to fasten small mirrors, cardboard, reflectors, filters, foils, etc.

Plate Ø: 42 mm (1.65")  
Weight: 40 g (0.1 lbs)



### COFLE

Fleece stickers to holder plate COFLA, or to secure a laptop on holder ARTEU. Set of 8.

Sticker Ø: 40 mm (1.57")  
Weight of set: 10 g (0.02 lbs)



The CESTO plate prevents intrusive reflections from below when shooting wine bottles or other reflective subjects.

### CESTO

Round plate with 3/8" removable stub screw. Can therefore be fastened onto a female (with screw) or male (without screw) COMBITUBE.

Very useful to set a camera or other objects on the end of a vertical COMBITUBE.

Length of stub screw: 4 cm (1.57")  
Plate Ø: 5 cm (1.97")  
Plate thickness: 1 cm (0.39")  
Weight: 70 g (0.15 lbs)



## Clamps and holders



### COGLA

Set of 3 metal sheets in various sizes.

The metal sheets can be used directly as brighteners or reflectors. They can also be covered with textiles and other materials, or suitably painted. With rounded corners.

Small metal sheet:	7x7 cm (2.75x2.75")
Medium metal sheet:	12x15 cm (4.7x5.9")
Big metal sheet:	15x20 cm (5.9x7.9")
Thickness:	0.5 mm (0.02")
Total weight of all 3 sheets:	70 g (0.15 lbs)

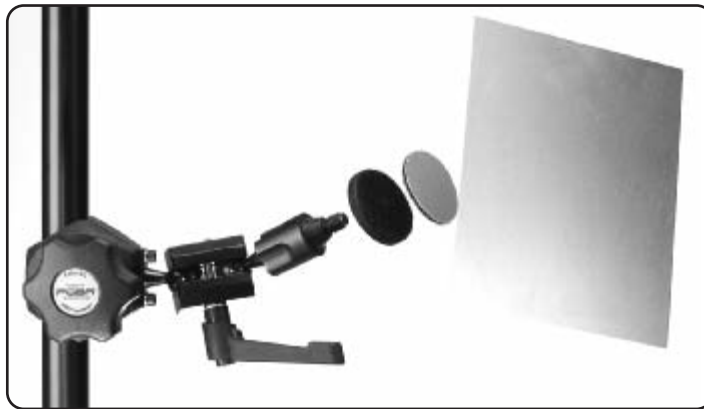

One way to fasten a COGLA metal sheet:

- COFLA fleece sticker
- COFLA holder plate
- CEKLU all-purpose joint



### RODEE

Lamp adapter, top 5/8", bottom female COMBITUBE connector.

Top 3/8" male thread	
Outside Ø top:	16 mm (5/8")
Outside Ø bottom:	25 mm (1")
Lower end:	COMBITUBE female cone
Height w/o top thread:	72 mm (2.8")
Weight:	120 g (0.26 lbs)



### CIBAN

Adapter, COMBITUBE to M6 thread.

- Top with female M6 tap, fits e.g. former Graf articulated arm
  - Bottom with female COMBITUBE cone
- |           |                 |
|-----------|-----------------|
| Length:   | 4.5 cm (1.8")   |
| Diameter: | 25 mm (1")      |
| Weight:   | 50 g (0.11 lbs) |



Small object holders:

On one COMBITUBE diverse connectors/adapters or supports (with a COTWE between them depending on situation) for various object sizes. Seen here: COFLA, CODEA, CESTA, CIBAF.



### CEBLO 1/4

3/8" to 1/4" thread adapter, radially bored for tightening bar.

Top:	1/4" male thread
Bottom:	3/8" female thread
Length without male thread:	30 mm (1.2")
Outside diameter:	18 mm (0.7")
Weight:	50 g (0.1 lbs)



The CEBLO 1/4 thread adapter is a boon for working with small-format cameras and other equipment with 1/4" tapped threads.



STAPI telescopic upright with CESTO plate and modelling paste: the subject is fixed securely and without reflections.



### COBLO 5 / COBLO 10

Transition piece for precisely positioning small objects.

Upper hole Ø:	5 mm (3/16")
	10 mm (3/8")
Bottom:	tapped 3/8"
Length:	5 cm (2")
Outside Ø:	25 mm (1")
Weight:	170 g (0.37 lbs)



Typical application of COBLO 5

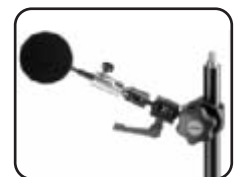

COMBITUBE with:

- CEKLU, all-purpose joint
- COBLO 5, transition piece
- Black flag

## Articulated arms



**CEKLU**  
All-purpose joint with COMBITUBE connector; free positioning in every direction.  
Weight: 380 g (0.84 lbs):



**COKLI**  
All-purpose joint with clamp, to position cardboard, styrofoam, reflectors, etc. in any position on a COMBITUBE.  
Weight: 420 g (0.92 lbs):



**COFLO / COFLU**  
Gooseneck arm with 3/8" thread, to position small objects, paper, cardboard etc. Extremely strong.

**COFLO**  
Length: 20 cm (7.87")  
Weight: 160 g (0.35 lbs)

**COFLU**  
Length: 40 cm (15.75")  
Weight: 320 g (0.7 lbs)



**CIBAE**  
The CIBAE articulated arm has the following features:  
– Synchronized locking or release of all three joints with the hand knob  
– Light and handy  
– Non-rotating bolt connector for CIBAK clamp or CIBAL extension at top  
– COMBITUBE connector at bottom.

Length: 27 cm (10.6")  
Weight: 310 g (0.68 lbs)



**CEKLI**  
Useful fitting for CEKLU and COKLI arms.

Top: Ball  
Bottom: Female cone for COMBITUBE  
Length: 8 cm (3.1")  
Outside Ø: 25 mm (1")  
Weight: 190 g (0.4 lbs)



**CEKLA**  
Useful fitting for CEKLU and COKLI arms.

Top: Ball  
Bottom: Male cone for COMBITUBE  
Length: 8.5 cm (3.3")  
Outside Ø: 25 mm (1")  
Weight: 170 g (0.37 lbs)



Locking of the three joints takes place progressively from bottom to top with one single knob, thereby achieving an unprecedented degree of precision.

The joints are released in the opposite order, from top to bottom, with the same knob.

**CIBAO**  
Its progressive locking mechanism makes the CIBAO articulated arm unique worldwide. It is also very robust and can hold heavy items such as cameras, lamps etc. The CIBAO articulated arm has the following features:  
– Gradual locking of joints  
– Sturdy and very stable  
– 3/8" threaded COMBITUBE connectors top and bottom  
– Red adapter indicates the joint first locked and last released (bottom)

Length: 25 cm (9.9")  
Weight: 490 g (1.08 lbs)



**CIBAU**  
The lightweight CIBAE synchronized clamping arm is also available in a kit with CIBAF middle sized support and one CIBAK clamp. CIBAU is the "third hand" photographers dream of: accurate and finely tuned setup of subject, mirrors, filters, etc. made easy.  
Weight: 3.2 kg (7.05 lbs)



Small flashlight fixed to a COMBITUBE with RODEE lamp adapter and CEKLU joint.



The middle of the COKLI and CEKLU arms can be opened to fit CEKLI and CEKLA arms as needed.



Typical combinations of CEKLU / COKLI arms with CEKLI fitting.

**FOBA CIBAE, CIBAO and CEKLU articulated arms, with suitable adapters as necessary, fit COMBITUBE elements and former GRAF system.**



**COMEN**  
Holder kit with touch fastener. Simplifies your table-top shoots. The gooseneck arm is easily set in place, and all kind of small things can be attached to the COFLA holder plate.

Consists of:  
1 CEBRO, small support  
1 COFLO, gooseneck arm 20 cm (7.9")  
1 COFLA, holder plate with touch fastener (includes 8 fleece stickers COFLE).

Weight: 1.35 kg (2.98 lbs)



The gooseneck arm lets you set up filters, mirrors and other flat objects quickly and easily, and remove them just as fast. The touch fastening makes it possible. In a nutshell: a small but very useful helper on your shooting table.



# FOBA articulated arms: limitless creativity thanks to modularity

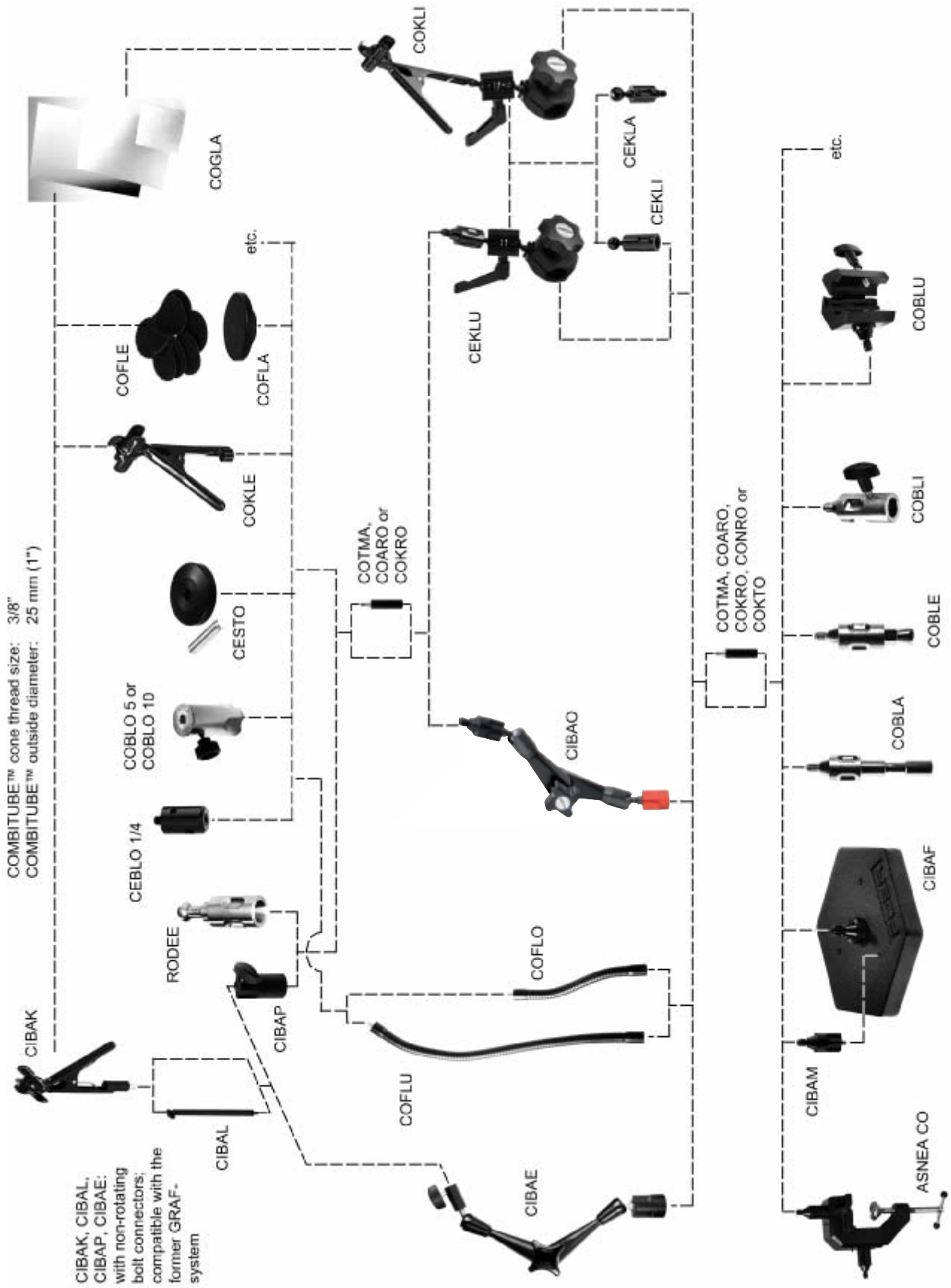

## Holders for lamps and accessories

The FOBA product range includes 2 lamp holders (CEONO / SAONO sliding clamp, CEHUA / CEHUO exchange sleeve) fitting a large selection of interchangeable adapters for lamps and other accessories. They make moving lamps or changing setups quick and easy.



### CEHUA / CEHUO

Sleeves for various interchangeable adapters at 18 mm (0.7") diameter. The bottom has either a female COMBITUBE connector (CEHUO) or a simple 3/8" tap (CEHUA) for installation on lamp stand uprights (COMBITUBE or STAPI telescopic upright). The ARTEU laptop holder can also be fitted into CEHUA / CEHUO sleeves.

#### CEHUA

Bottom: tapped 3/8"  
 Inside Ø of sleeve: 18 mm (0.7")  
 Outside Ø: 25 mm (1")  
 Height: 4 cm (1.57")  
 Weight: 100 g (0.2 lbs)

#### CEHUO

Bottom: female COMBITUBE connector (cone and 3/8" tap)  
 Inside Ø of sleeve: 18 mm (0.7")  
 Outside Ø: 25 mm (1")  
 Height: 5 cm (1.97")  
 Weight: 130 g (0.3 lbs)



### CESTA

Plate for COMBITUBE end, includes wing nut tapped 3/8".

Diameter: 80 mm (3.1")  
 Height: 28 mm (1.1")  
 Weight: 130 g (0.29 lbs)

### CEONO

Sliding clamp with trigger, smooth and continuous movement (up, down, rotary). The front sleeve can be fitted with FOBA's large range of interchangeable 18 mm (0.7") diameter adapters and holders.

For Ø 25 mm (1") tubes and COMBITUBE.  
 Distance mid-tube to mid-sleeve: 21 cm (8.27")  
 Front sleeve inner Ø: 18 mm (0.7")  
 Weight: 670 g (1.5 lbs)

The SAONO sliding clamp fits 30 mm (1.2") tube diameters.

**The following interchangeable adapters fit sliding clamps CEONO / SAONO, extension CEONA and sleeves CEHUA / CEHUO:**



### CEBLI

All-purpose lamp adapter, 5/8" with radial boring for tightening bar.

Outside diameter, top: 16 mm (5.8")  
 Length, top: 32 mm (1.26")  
 Outside dia., bottom: 18 mm (0.71")  
 Length, bottom: 35 mm (1.38")  
 Tapped 3/8" at bottom  
 Weight: 100 g (0.22 lbs)



### CEBLA

Adapter for Broncolor lamps, with radial boring for tightening bar.

Top: 3/8" thread  
 Length without top thread: 77 mm (3.03")  
 Bottom diameter: 18 mm (0.71")  
 Tapped 3/8" at bottom  
 Weight: 80 g (0.18 lbs)



With CESTA, lamps with brackets are fixed easily and securely.

Left: Detail of the installation / Right: Lampholder support  
 – Base plate **CESRA**  
 – COMBITUBE **COKRO** 40 cm  
 – Plate **CESTA**



### CEBLO 3/8

Interchangeable adapter with 3/8" thread at top. For mounting lamps, tripod heads, cameras, etc., with radial boring for tightening bar.

Top: 3/8" thread  
 Outside diameter: 18 mm (0.71")  
 Length without top thread: 3 cm (1.18")  
 Weight: 60 g (0.13 lbs)



### CEBLO 1/4

As CEBLO 3/8, but 1/4" thread at top and additionally tapped 3/8" at bottom (see page 15)

### COLBE

Interchangeable adapter with 3/8" thread and wing nut, to attach various components.

Length without thread: 35 mm (1.38")  
 Length of thread: 20 mm (0.78")  
 Outside diameter: 18 mm (0.71")  
 Weight: 85 g (0.19 lbs)

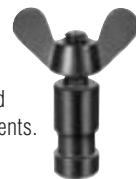

### CEONA

Extension for sliding clamps. The front sleeve takes the same interchangeable adapters and holders as CEONO / SAONO sliding clamps.

Front sleeve inside dia.: 18 mm (0.71")  
 Outside diameter of the adapter: 18 mm (0.71")  
 Extension length: 8.5 cm (3.3")  
 Weight: 325 g (0.71 lbs)



### CEPRO

Interchangeable adapter with adjustable and removable hook.

Tapped 3/8" at bottom  
 Height: 5 cm (1.97")  
 Outside diameter: 18 mm (0.71")  
 Hook length: 12 cm (4.7")  
 Weight: 160 g (0.35 lbs)



### CORPO

Interchangeable adapter, forked. For DAPAO / DAPAA clamping devices on COMBITUBE elements. 1 pair.

Bottom 3/8" tap  
 Height: 9 cm (3.5")  
 Outside diameter: 18 mm (0.71")  
 Weight: 240 g (0.5 lbs)

## Supports for lamps and other accessories



### STAPI

Telescopic upright, 3 elements. Tapped at bottom for adding COMBITUBE extensions. Top with 5/8" lamp adapter and additional 3/8" thread.

Outside dia. of top tube: 16 mm (5/8")  
 Outside dia. of lower tube: 25 mm (1")  
 Extension: 75-160 cm (29.5-63")  
 Weight: 750 g (1.65 lbs)

### COMON

Lamp stand on plate, with sliding clamp for quick and precise lamp positioning. Useful for placing lights low down (20 cm above the floor) or up to 1.6 m. Can be extended by adding COMBITUBES on top.

Add a CESRU weight to the plate for greater stability.

COMON consists of:

- 1 **CESRA** round support, large
- 2 **CONRO AS** COMBITUBE 80 cm
- 1 **CEONO** sliding clamp
- 1 **CEBLI** all-purpose lamp adapter

Height: 1.65 m (65")  
 Weight: 12 kg (26 lbs)



COMON lampstand in use with DIMIL shooting table

### STAPU

3-part adjustable aluminium stand with telescopic upright. Can be extended by adding COMBITUBES from below.

STAPU consists of:

- COSNO AS** folding lightweight tripod
- STAPI** telescopic upright

Height, open: 1.7 m (66.9")  
 Length, closed: 0.8 m (31.5")  
 Weight: 1.5 kg (3.3 lbs)



COMBITUBE elements for holding reference marks (example of an industrial application).



### CEHUI

Exchange sleeve to COMBITUBE for various 16 mm (5/8") diameter fittings.

Top inside sleeve Ø: 16 mm (5/8")  
 Outside Ø: 25 mm (1")  
 Height: 62 mm (2.4")  
 Bottom: COMBITUBE female cone  
 Weight: 170 g (0.37 lbs)



### RODOI 1 / RODOI 2

Connecting rod (from the product line Ceiling Rail\* Systems); both ends take 5/8" lamp adapters; with safety screw and locknuts.

Inside Ø: 16 mm, fits 5/8"  
 Outside Ø: 25 mm (1"), fits COMBITUBE

### RODOI 1

Length: 50 cm (19.7")  
 Weight: 420 g (0.93 lbs)

### RODOI 2

Length: 1 m (39.4")  
 Weight: 840 g (1.85 lbs)



### RODUO

Connecting sleeve (short version of RODOI connecting rod); both ends take 5/8" (16 mm) lamp adapters; with safety screw and locknuts.

Length: 65 mm (2.56")  
 Inside Ø: 16 mm, fits 5/8"  
 Outside Ø: 25 mm (1"), fits COMBITUBE  
 Weight: 90 g (0.2 lbs)



### RODUA

Lamp adapter, top 5/8", bottom male COMBITUBE connector.

Length overall: 8 cm (3.1")  
 3/8" thread at top  
 Outside dia. top: 16 mm (5/8")  
 Outside dia. bottom: 25 mm (1")  
 Weight: 130 g (0.29 lbs)



### RODEE

As RODUA but with COMBITUBE female cone. (see page 15)



### RODAU

5/8" all-purpose adapter with 3/8" and 1/4" threads.

Length without thread: 62 mm (2.44")  
 Outside diameter: 16 mm (5/8")  
 Weight: 70 g (0.15 lbs)



### RODEA

5/8" adapter and adapter for Broncolor lamps.

Bottom length to collar: 32 mm (1.26")  
 Bottom outside diameter: 16 mm (5/8")  
 Weight: 95 g (0.21 lbs)

## Other versatile elements



### CEGOU

2 kg sliding weight to counterbalance an object at the other COMBITUBE end. Strong spring clip fixing.

Outside Ø: 8.5 cm (3.3")  
Hole Ø: 25 mm (1")  
Thickness: 5 cm (1.97")  
Weight: 2 kg (4.4 lbs)



### CEGEE 25

Safety ring, hole Ø 25 mm (1").

Height: 15 mm (0.6")  
Weight: 170 g (0.37 lbs)



### COBRI

Transparent brochure holder, size A4, with fittings, to fasten to a COMBITUBE. Contents thickness max. 4 cm (1.6").

Weight: 880 g (1.94 lbs)



COBRI at work on a COMBITUBE



### CESTU

Camera plate with reversible 1/4" and 3/8" threads. To attach a camera or a tripod head on a COMBITUBE.

Plate Ø: 54 mm (2.1")  
Height w/o screw: 56 mm (2.2")  
Hole Ø: 25 mm (1")  
Weight: 200 g (0.44 lbs)



Usage of the camera plate CESTU



### COTIO

Round accessory tray, aluminium, female COMBITUBE connector at bottom center.

Useful as an object stand and to keep small ends close at hand in the studio.

Diameter: 48 cm (18.9")  
Weight: 1.4 kg (3.1 lbs)



### ARTEU

Aluminium laptop holder for 17" monitor size, with ventilation holes and large corner holes for computer cable binders.

With adhesive Velcro and COFLE fleece stickers for laptop securing. Swivel head underneath fits CEHUA / CEHUO exchange sleeves.

Including swivel arm for mounting laptop holder on the crosspiece of FOBA stands\*.

Width: 40 cm (15.7")  
Depth: 32 cm (12.6")  
Arm length: 33 cm (13")  
Weight: 2 kg (4.4 lbs)



Thanks to its infinitely adjustable swivel head, the ARTEU laptop holder also holds projectors and other equipment precisely and dependably in position:

- STARE small dolly
- CESRU weighting plate
- CONRO AS, COMBITUBE 80 cm
- CEONO sliding clamp
- CEBLO 3/8" interchangeable adapter
- CEHUA exchange sleeve
- ARTEU laptop holder



Safety:

- Thanks to cable binders: no torn laptop cable.
- Thanks to Velcro pads and fleece stickers (COFLE): computer stays safely on the holder.

## Background holders and swivel arms

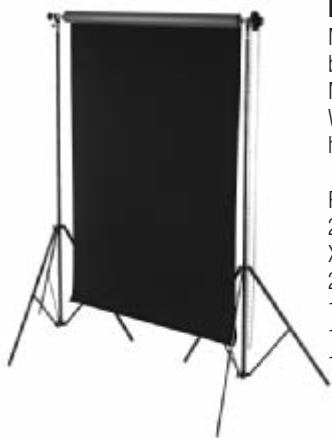

### Background stand

Mobile COMBITUBE™: Wherever you are, take your backgrounds with you.

Mobile roll stand made with COMBITUBE elements. Width according to use. Easy to assemble, light and handy, just right to take along on fieldwork.

Parts required for this particular build:  
 2 **COSTO** or **COSNO AS** folding tripods  
 X COMBITUBE **CONRO**, **COKRO** etc. according to height  
 2 **CEHUO** tapped sleeves  
 1 pair **CORPO** forkpieces  
 1 **DAPAO** clamping set with chain  
 1 **DAPSI** or **DAPSO** trailing edge strip, according to paper width



Swiveling stand to suspend background sheets, fabrics etc. Includes a counterbalance weight.

An optional **CESRU** weighting plate on the support foot improves stability.

Consists of:

- 1 **CESRA**, round support, large
- 4 **CONRO AS**, COMBITUBE 80 cm
- 1 **COGEA**, articulated connector, 7° steps
- 1 **CEGOU**, sliding weight 2 kg
- 1 **COKLO 5**, COMBITUBE clamp, set of 5

Weight: 14 kg, (31 lbs)

### COMUN

Portable stand for background material, width up to 2.8 m (110").

**COMUN** consists of:

- 2 **COSNO AS**, small folding tripod
- 1 **COKRO AS**, COMBITUBE 40 cm
- 9 **CONRO AS**, COMBITUBE 80 cm
- 1 **COGEA**, articulated connector, 7° steps, set of 2
- 1 **COKLO 5**, clamp, set of 5

Weight: 5 kg (11 lbs)

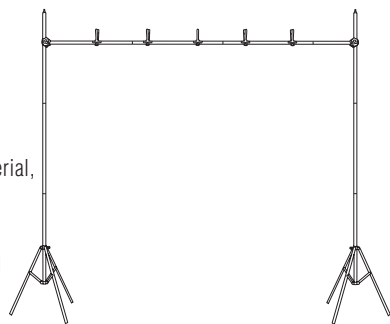

### CAMUN

Swivel arm, facilitates working with the FOBA shooting table\*; swivels in steps of approximately 7°.

**CAMUN** consists of:

- 2 **COKRO AS**, COMBITUBE 40 cm (15.7")
- 1 **COGEA**, articulated connector, 7° steps
- 1 **COFLO**, gooseneck arm 20 cm (7.9")
- 1 **COKLE**, COMBITUBE clamp, tapped 3/8"
- 1 **COKLO**, COMBITUBE clamp

Weight: 1.2 kg (2.6 lbs)

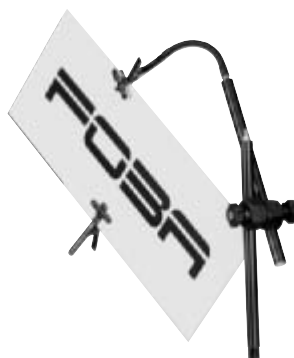

### Holder for diffuser sheet

Consists of:

- 2 **CESRA**, large support
- 2 **CONRO AS**, COMBITUBE 80 cm (31.5")
- 4 **COKLO**, clamps

### Stepless swivel arm

Articulated, 360° connector **COGEU** gives the swivel arm great continuous mobility. The **CEGOU** sliding weight at the back counterbalances even heavy loads at the front end. Safety ring **CEGEE 25**, at the end of the COMBITUBE, prevents the weight from sliding off accidentally.



\* For more information on the robust, colour-neutral and shadow-free FOBA shooting tables, see [www.foba.com](http://www.foba.com)

## Index of products

Product	Page	Description
ARTEU	20, 14, 18	Holder for laptops, rectangular
ASGME	12, 13	Tip for COMBITUBE and ALFAE / ASNIO, tripods
ASNEA CO	12, 17	Clamp for COMBITUBE
ASNIO	13, 12	Mini tripod, extra sturdy
ASSME	12, 13	Removable rubber cap for ASGME
CAMAX	7	COMBITUBE kit MAXI
CAMID	7	COMBITUBE kit MIDI
CAMIN	7	COMBITUBE kit MINI
CAMUN	21	Swivel arm, 7° steps
CARRI	12	Mounting flange, male COMBITUBE conn.
CEBLA	18	Adapter, Broncolor lamps, bottom 3/8" tap
CEBLI	18, 19	Lamp adapter 5/8", all-purpose, bottom 3/8" tap
CEBLO 1/4	15, 17, 18	Interchangeable adapter, top 1/4" thread, bottom 3/8" tap
CEBLO 3/8"	18, 20, 22	Interchangeable adapter, top 3/8" thread
CEBRO	10, 16	Support, 1.1 kg, male COMBITUBE connector
CEGEE 25	20, 13, 21	Safety ring, hole Ø 25 mm, COMBITUBE
CEGOU	20, 21	Sliding weight 2 kg, inner-Ø 25 mm, for COMBITUBE
CEHUA	18, 20	Exchange sleeve 18 mm, bottom tapped 3/8"
CEHUI	19	Exchange sleeve 16 mm (5/8"), bottom COMBITUBE
CEHUO	18, 20, 21	Exchange sleeve 18 mm, bottom COMBITUBE
CEKLA	16, 17	Male COMBITUBE-Adapter with ball
CEKLI	16, 17	Female COMBITUBE-Adapter with ball
CEKLU	16, 17, 15, 7, 14	All-purpose joint for COMBITUBE
CEONA	18, 13	Extension for sliding clamps CEONO / SAONO
CEONO	18, 13, 19, 20, 22	Sliding clamp, COMBITUBE, hole Ø 25 mm
CEPRO	18	Interchangeable adapter, adjustable hook
CESRA	10, 18, 19, 21	Support, large, 9.5 kg, with male COMBITUBE connector
CESRO	10	Dolly, large, for tube Ø 30 / 25 mm
CESRU	10, 19, 20, 21, 22	Weighting plate 9.4 kg, round, to CESRA / STARE
CESTA	18, 15	Top plate with wing nut 3/8", COMBITUBE
CESTO	14, 15, 17	Plate, round, with 3/8" stub screw
CESTU	20	Camera plate for COMBITUBE
CIBAE	16, 17, 23, 14	Articulated arm, synchronized, light
CIBAF	10, 17, 15, 16	Support, middle size, 2.5 kg, with male COMBITUBE connector
CIBAK	14, 17, 23, 16	Clamp with non-rotating bolt connector
CIBAL	14, 17, 23	Extension 20 cm, with 2 non-rotating bolt connections
CIBAM	10, 17	Adapter, top male COMBITUBE conn., bottom threaded M6 (GRAF)
CIBAN	15	Adapter, top M6 tap (GRAF), bottom female COMBITUBE conn.
CIBAO	16, 17, 23, 11, 14	Articulated arm, progressive, sturdy
CIBAP	14, 17	Adapter, top bolt connector, bottom female COMBITUBE connector
CIBAU	16	Simultaneous articulated arm CIBAE, set, with support and clamp
COARO AS	8, 7, 11	COMBITUBE 20 cm alu black
COARO CL	8	COMBITUBE 20 cm steel, nickel-plated
COBLA	11, 17	COMBITUBE adapter for griphead
COBLE	11, 17	COMBITUBE adapter for superclamp
COBLI	11, 17	COMBITUBE adapter for lampadapter 5/8"
COBLO 10	15, 17	Transition piece, tapped 3/8", hole Ø 10 mm
COBLO 5	15, 17, 11	Transition piece, tapped 3/8", hole Ø 5 mm
COBLU	11, 17	Hinged COMBITUBE connector, Ø 5/8"
COBRI	20	Brochure holder, size A4, with fitting for COMBITUBE
CODEA	9, 15, 7, 6	Right-angle connector
CODIO	9, 7, 6	Cross connector for 2 COMBITUBE
COFLA	14, 17, 11, 15, 16, 23	Holder plate with Velcro incl. set of 8 fleece stickers
COFLE	14, 17, 11, 15, 16, 20, 23	Fleece stickers, set of 8, to COFLA, COMEN, ARTEU
COFLO	16, 17, 21, 14, 7, 6	Gooseneck arm 20 cm
COFLU	16, 17, 14, 7, 6	Gooseneck arm 40 cm
COGAE	12, 7	All-purpose screw clamp
COGEA	9, 21, 11, 7, 6	Articulated connector, 7° steps, set of 2
COGEU	9, 21	Articulated connector, 360°, continuous
COGLA	15, 17, 11, 23	Metal sheets, set of 3 sizes



Sturdy, versatile and accurate: Ceiling rails with COMBITUBE. With COMBITUBE side bracing, lamps and brightener/reflector can be fixed with otherwise hardly attainable precision.



Shooting on site is never a problem with COMBITUBE. Setup takes no time at all.



FOBA shooting tables: an overhead COMBITUBE assembly firmly holds the subject, reflector and lamps to free up the shooting tabletop.



Low-level shooting is easy with COMBITUBE. This little portable tripod enables fast adjustments in all directions:

- STARE, small dolly
- CESRU, weighting plate
- CONRO AS, COMBITUBE 80 cm
- CEONO, sliding clamp
- CEBLO 3/8", interchangeable adapter
- BENTA, ballhead\* SUPERBALL® M-1

## Produktverzeichnis

Product	Page	Description
COGUO	12, 7	Plastic foot for COMBITUBE, set of 2
COKLE	14, 17, 10, 21, 7, 6	COMBITUBE clamp, 3/8" tap
COKLI	16, 17, 7	All-purpose joint with clamp
COKLO	14, 21, 6, 2	COMBITUBE clamp
COKLO 10	14	COMBITUBE clamp, set of 10
COKLO 5	14, 21, 7	COMBITUBE clamp, set of 5
COKRO AS	8, 18, 21, 7	COMBITUBE 40 cm alu black
COKRO CL	8	COMBITUBE 40 cm steel, nickel-plated
COKTO AS	8	COMBITUBE 160 cm alu black
COKTO CL	8	COMBITUBE 160 cm steel, nickel-plated
COLBE	18	Interchangeable adapter with wing nut 3/8"
COLRU	12	Caster for COMBITUBE, DIGRO / DIBRO
COMEN	16	Holder kit with touch fastening
COMON	19	Lamp stand, COMBITUBE
COMUN	21	Background holder, COMBITUBE kit
CONRO AS	8, 19, 20, 21, 22, 7, 6	COMBITUBE 80 cm alu black
CONRO CL	8	COMBITUBE 80 cm steel, nickel-plated
CORPO	18, 21	Interchangeable adapter, forked, 1 pair
COSNO AS	10, 19, 21, 7	Folding tripod, alu, 65 cm
COSTO	10, 21	Folding tripod, steel, 95 cm
COTIO	20	Round accessory tray, COMBITUBE conn.
COTMA AS	8	COMBITUBE 6 cm, alu black
COTMA CL	8	COMBITUBE 6 cm steel, nickel-plated
COTRA	9	T-connector for 3 COMBITUBE
COTRI	9, 23	Hinged connector for COMBITUBE
COTRU	9	Triangle connector for 3 COMBITUBE
COTTO AS	8	Tube, 6 cm, 2 male COMBITUBE conn., alu, black
COTWE	8, 15	Tube, 6 cm, 2 female COMBITUBE conn., alu, black
DOPLO	12	Side brackets to DIGRO / DIBRO, pair
RODAU	19	All-purpose adapter 3/8"- and 1/4"-threads
RODEA	19	Adapter for Broncolor lamps
RODEE	15, 17, 10, 16, 19	Lamp adapter, female COMBITUBE connector
RODOI 1	19	Connecting rod 50 cm, 5/8"-hole
RODOI 2	19	Connecting rod 100 cm, 5/8"-hole
RODUA	19	Lamp adapter, male COMBITUBE conn.
RODUE	19	Adapter with wing nut, 3/8", all-purpose
RODUO	19	Connecting sleeve, 5/8"-hole
ROTUO	13	Trolley, COMBITUBE conn., ROOF-TRACK
STAPI	19, 11, 15, 18	Telescopic upright, COMBITUBE conn.
STAPU	19	Stand, foldable, telescopic, for COMBITUBE
STARE	10, 20, 22	Dolly, small, for COMBITUBE (Ø 25 mm)



The COGLA plate fixes to the CIBAO articulated arm by COFLE adhesive fleece stickers and COFLA holder plate with Velcro. The articulated arm is fixed to the COMBITUBE with COTRI hinged connector.



Brightener fixed with CIBAE articulated arm on COMBITUBE with CIBAL extension and CIBAK non-rotating clamp.



CIBAE and CIBAO articulated arms: truly versatile thanks to modularity.

### Did you want to know more about FOBA products mentioned without detailed description in the current catalogue?

Product	mention on page	Description	find more in catalogue:
ALFAE	13, 12	Top Alu tubular tripod	Studio stands
BENTA	22	SUPERBALL M-1 with camera plate	Tripod heads
DAPAA	18	Clamp inserts, 1 pair, with brake	Studio backgrounds, shooting tables
DAPAO	18, 21	Clamping device assembly with brake, chain wheel and chain, pair	Studio backgrounds, shooting tables
DAPSI	21	Trailing edge strip, 1.30 m	Studio backgrounds, shooting tables
DAPSO	21	Trailing edge strip, 2.75 m	Studio backgrounds, shooting tables
DIBRO	12	Shooting table, large, width 160 cm	Studio backgrounds, shooting tables
DIGRO	12	Shooting table, large, width 130 cm	Studio backgrounds, shooting tables
DIMIL	19	Shooting table, middle, width 123 cm	Studio backgrounds, shooting tables
RAGIE	13	Twin-wheels trolley, COMBITUBE conn., MEGA-TRACK	Ceiling Rail System
REGIE	13	Trolley with COMBITUBE connector, MEGA-TRACK	Ceiling Rail System
SANRO	10, 18	Upright for lamp stand, Ø 30 mm, stainless steel	Studio backgrounds, shooting tables
SAONO	18	Sliding clamp, hole Ø 30 mm for SANRO	Studio backgrounds, shooting tables

### FOBA quality for professional photography

For more than 70 years FOBA has been supporting professional photographers with first-class and dependably sturdy modular studio equipment, traditionally crafted from exclusive materials. The COMBITUBE™ system is so practical and ingenious that meanwhile it is also used in other areas, such as for industrial and interior design applications, etc.

Apart from the practical and ingenious COMBITUBE™ system, FOBA is also reputed for world-class studio stands and tripods, SUPERBALL® ballheads, shooting tables, unroller devices, turntables, ROOF-TRACK and MEGA-TRACK Ceiling Rail Systems.



**FOBA COMBITUBE™:**  
for limitless  
**creativity**

**FOBA**®  
STUDIO-TECHNOLOGY

FOBA AG  
Friedgrabenstrasse 21  
CH-8907 Wettswil  
Switzerland

☎ +41 44 701 90 00  
☎ +41 44 701 90 01

info@foba.com  
www.foba.com

## Das FOBA Sortiment

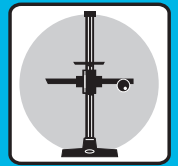

FOBA STUDIO STANDS, TRIPODS  
FOBA STATIVE  
FOBA PIEDS À COLONNE, TRÉPIEDS



FOBA TRIPOD HEADS  
FOBA STATIVKÖPFE  
FOBA TÊTES DE TRÉPIEDS

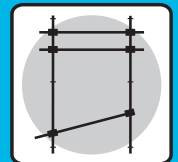

FOBA CEILING RAIL SYSTEM  
FOBA DECKENSCHIENEN-SYSTEM  
FOBA SYSTÈME RAILS DE PLAFOND

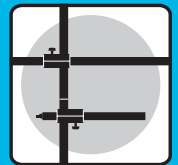

FOBA COMBITUBE SYSTEM  
FOBA COMBIROHR® SYSTEM  
FOBA SYSTÈME COMBITUBE



FOBA SHOOTING TABLES  
FOBA AUFNAHMETISCHE  
FOBA TABLES DE PRISE DE VUE



FOBA TURNTABLES  
FOBA DREHTELLER  
FOBA TABLES TOURNANTES