

sinar

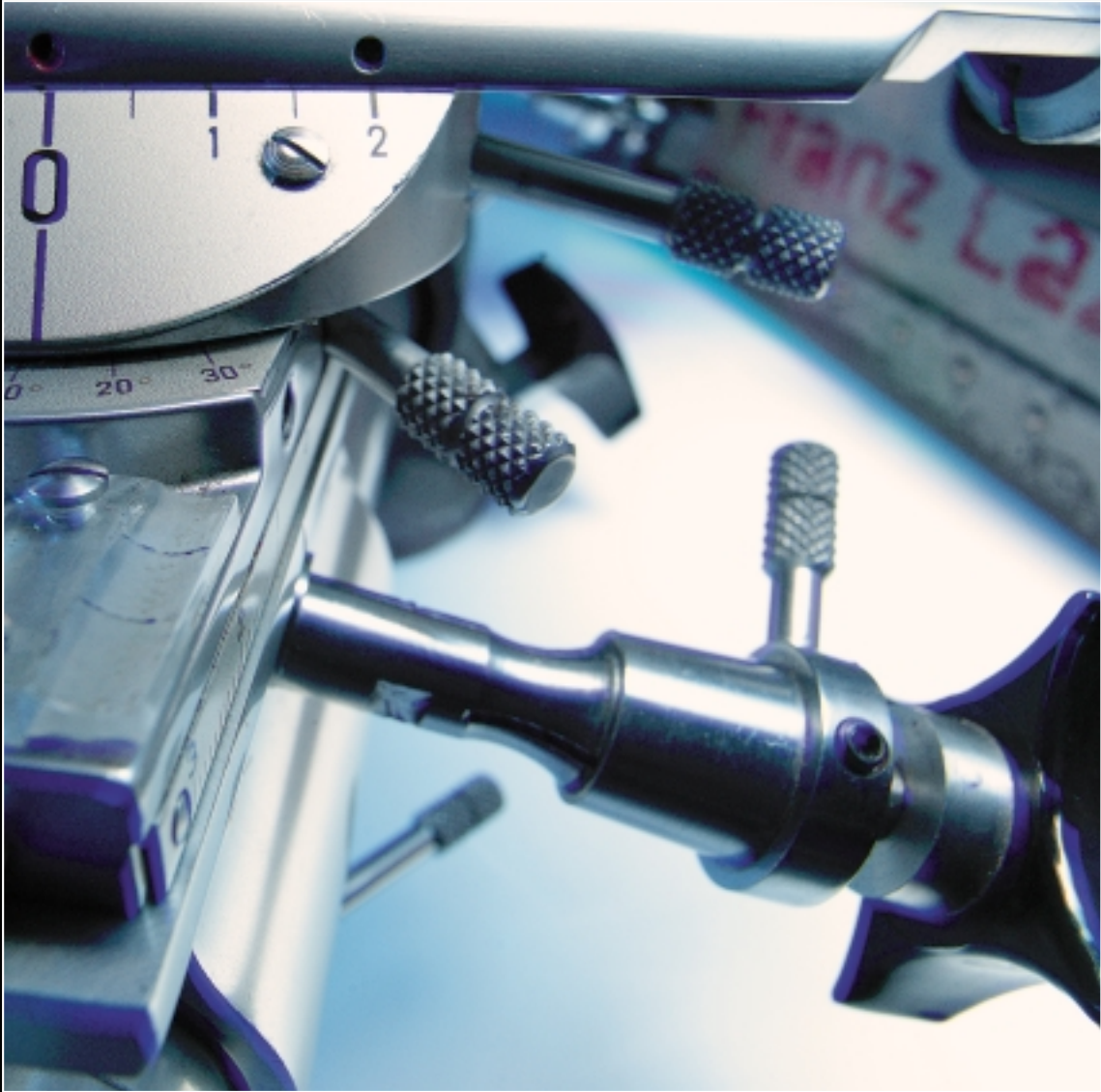

System Catalogue

2000/2001



The extraordinary versatility of view cameras expands the seemingly rigid boundaries of photography, providing the photographer with entirely new degrees of creative freedom.

The film and lens planes on adjustable camera platforms from Sinar can easily be shifted for very convenient perspective corrections and even for modifications.

By working with the camera's features, the photographer can skillfully use its swings and tilts to define the planes of sharpness and unsharpness in such a way as to convey precisely the desired pictorial expression to the viewer.



We are well into the era of digital networking. Large photographic businesses recognized the advantages of digital imaging (from original exposure to printed page). The flexibility of the Sinar System makes it easy, for instance, to attach a digital back to a Sinar p2, creating a perfect professional digital camera, one that matured from its infancy long ago and that is in full active use in a great many locations.

The Otto Mail Order House, largest enterprise of its kind in the world, utilizes the many advantages of digital photography with the Sinar System.

Embarking in the Sinar System reveals that Sinar strives to produce the world's best professional cameras, and Sinar stands firmly behind its clients with an outstanding customer service.

The Sinar Workshops are a good example of that service. These experiences of one or more days with the wonders of large format photography are designed to demonstrate how its enormous capabilities can be utilized to optimal advantage. Participants from around the world expand their know-how in the Sinar Workshops. Because hardly any photographer wants to struggle with abstract theories, the Sinar Workshops are organized into small coherent groups to practice the efficient execution of sample assignments.

Sinar offers even more opportunities to become proficient with large format photography, such as Sinar-Info, issued several times a year to cover current topics. A major secret tip among photographers all over the world is the new series of books entitled "Creative Large Format" published by Sinar Edition. Its volumes on major subjects, like Basics, Architecture and Natural Landscapes describe how high-impact photographs are made that stand out in today's avalanche of pictures.

The Sinar f line is the most cost-effective entry into the Sinar System. For professionals concerned about weight, volume and budget, virtually nothing is more appropriate than the Sinar f.



The Sinar x is a cost-efficient alternative to the Sinar p2, performing all the functions with equal perfection, but deliberately dispensing with some of the amenities and upgrade possibilities.

The Sinar p line, worldwide symbol for superb professional cameras, is unsurpassed in versatility, precision, ruggedness and adjustment capabilities. The "p" stands for "perfection".

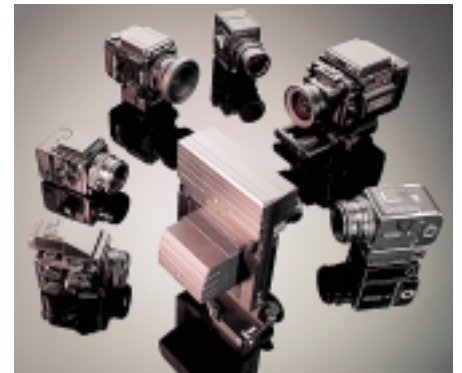

Sinar also offers a digital imaging system for demanding studio photography that integrates seamlessly into its proven Sinar view camera system and that can also be attached to medium format cameras: the Sinarback.

Transforming Ideas into Images

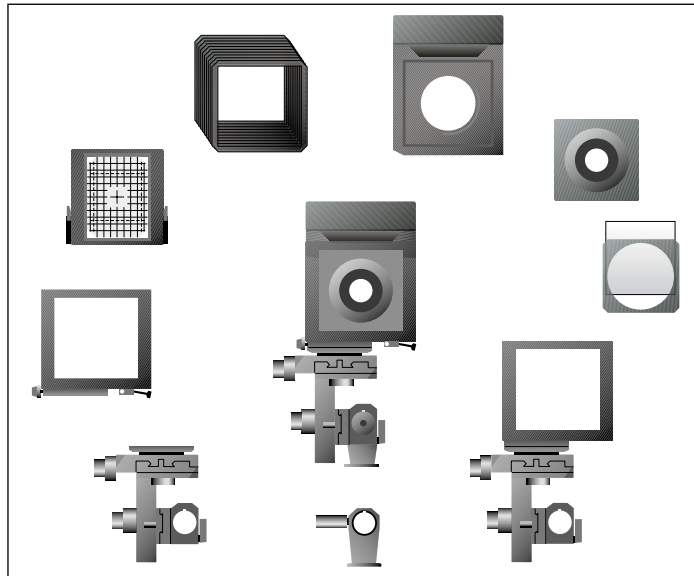

The professional photographer's job is becoming ever more demanding. His client expects innovative interpretations of ideas. Not only must these interpretations reflect prevailing trends, they must also conform to an established budget. And they must meet high expectations of quality. No two assignments are alike. The need for flexibility already

begins with the choice of the imaging medium. Depending on the nature of the assignment, the client may require images on rollfilm, sheet film, and increasingly on digital storage media.

Photography is writing with light and transforming ideas into images. The art consists of the skilled manipulation of light and shadows, the judicious application of sharpness and unsharpness and the creative choice of perspectives. Time constraints and technical limitations are the only restrictions on creativity and they sometimes become obstacles in the path to perfect photographs.

The evolution of 50 years of studio work, backed by innovative research and development has shaped today's Sinar System. The introduction of extremely versatile system components eliminated technical barriers in a revolutionary way and step-by-step opened new freedoms for creativity.

The Sinar Quality Chain

Every chain is only as strong as its weakest link. That motivates Sinar to pay special attention to the optimal compatibility of individual components with each other and to the uncompromised quality of each and every system element.

This guarantees the photographer that wonderfully reassuring confidence in the reliability of his camera. Individual camera and accessory components are designed to work smoothly with each other and without any impairment to handling. All cameras in the Sinar line of products are of equally high quality and, depending on the

composition of the outfit, they can be used for the greatest variety of assignments. Thus Sinar always equips the photographer with the ideal tools for transforming ideas into images quickly and perfectly.

The Modular System

The Sinar system was designed in such a way that the various camera models and accessories can be combined in numerous configurations. This enables the photographer to assemble exactly the right camera outfit that is optimally tailored to the assignment at hand.

Basic models of Sinar cameras:

- The first choice in the range of purely mechanical cameras is the **Sinar p2**. Thanks to its refined design, settings and focusing with the Sinar p2 can be accomplished faster than with any other camera. Not only does this save precious time, it also provides significant gains in precision. This model too, can be adapted for use as a digital camera.

- **The Sinarx** camera is available as a more affordable variation of the Sinar p2 that features the same robust construction and ease of use of the highly precise adjustment capabilities, but which deliberately omits certain other features.

- **The Sinarf1** and **f2** cameras are excellent as entry cameras for large format photography and as ideal cameras for outdoor photography. They are lightweight and

affordable, and their components are, of course, fully system-compatible.

- In conjunction with its digital imaging backs, Sinar offers a range of **Adapters** (see the Sinar digital catalogue entitled "Digital Performance"). These adapters and adapter kits make it possible to use the most popular

professional digital backs and the Sinarback on Sinar Cameras and on the most important medium format cameras.

- For professional digital photography in the studio, we recommend the compact **Sinarcams**, which provide an efficient way of working:

The Sinarcam2 for the Sinarback digital back can be used on its own as a compact studio camera and it can also be used in conjunction with Sinar p2 and Sinarx view cameras. The Sinarcam1 for the Leaf Volare and the Sinarcam3 for the Leaf Cantare digital back can also be used on their own as compact studio cameras, or they can be used in combination with a Sinar p2 camera.

Up-to-date Accessories

The convenience of the modular system is the fact that practically every individual component of the Sinar System can be used with every Sinar camera model. The line of accessories is constantly being expanded with new items, which can, of course, also be used with older Sinar cameras. For example, the versatile Sinar Rollfilm Holder Zoom2 with adjustable format masks, or the Expolux Shutter System.

Exposure metering probes permit quick determination of the correct exposure and they supply data for optimal contrast in the original for printing. The modern proprietary Sinar digital back, the Sinarback, in its various variations and with its ample range of accessories, can also be adapted with ease at any time.

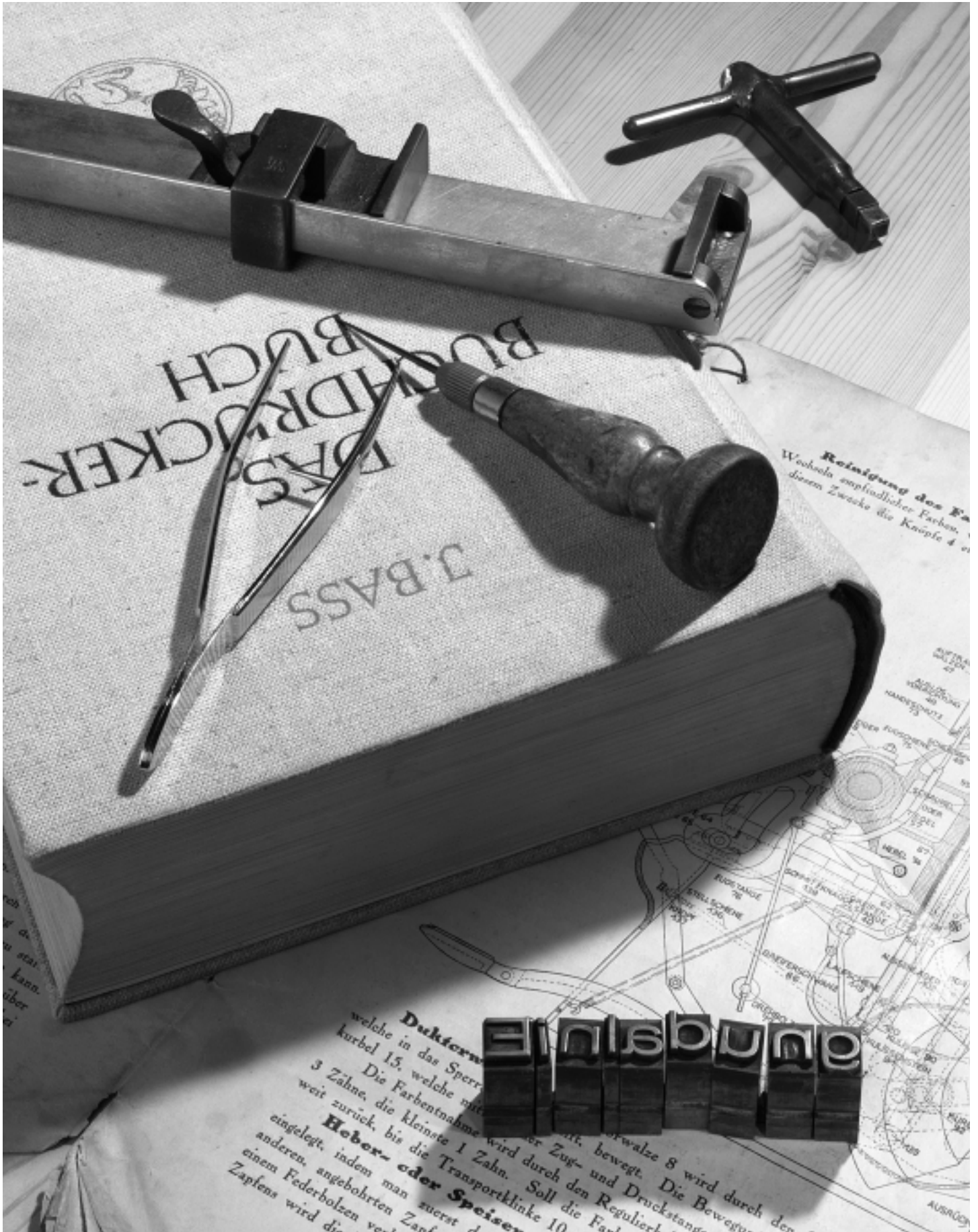



The Sinar p2

SINAR p2 4x5"/10x12.5 cm

491.76

Adjustment ranges:

Adjustment	
vertical:	↑ 4 cm, ↓ 4 cm
horizontal:	← 3 cm, → 5 cm
Coarse tilt:	± 45°
Fine tilt:	± 19°
Swivel:	± 50°
Fine focus:	5 cm
Bellows extension with	
Multipurpose bellows:	4 cm to 45 cm

SINAR p2 5x7"/13x18 cm

491.77

Adjustment ranges:

Vertical adjustment	
Rear standard:	↑ 5 cm, ↓ 2 cm
Front standard:	↑ 4 cm, ↓ 4 cm
Horizontal adjustments	
Rear standard:	← 5 cm, → 4 cm
Front standard:	← 3 cm, → 5 cm
Coarse tilt	
Rear standard:	± 30°
Front standard:	± 50°
Fine tilt:	± 19°
Swivel:	± 50°
Fine focus:	5 cm
Bellows extension	
with tapered bellows:	4 cm to 45 cm
Weight:	6,8 kg (15 lb)

SINAR p2 8x10"/20x25 cm

491.78

Adjustment ranges:

Vertical adjustment	
Rear standard:	↑ 5 cm, ↓ 0 cm
Front standard:	↑ 4 cm, ↓ 4 cm
Horizontal adjustments	
Rear standard:	← 6 cm, → 2 cm
Front standard:	← 3 cm, → 5 cm
Coarse tilt	
Rear standard:	± 20°
Front standard:	± 50°
Fine tilt:	± 19°
Swivel:	± 50°
Fine focus:	5 cm
Bellows extension	
with tapered bellows:	5 cm to 71 cm
Weight:	8,2 kg (18 lb)

Consists of:

411.41 Rail Clamp 2
 422.21 Basic Rail 12"/30 cm
 429.21 2 Rail Caps
 431.51 Front Standard p2
 433.26 Carrier Frame 4x5"/10x12.5 cm
 433.51 Bearer p2
 454.11 Multipurpose Bellows 4x5"/10x12.5 cm
 462.16 Metering Back 4x5"/10x12.5 cm
 531.41 Lensboard Holder

Weight: 5.9 kg (13 lb).



Sinar p2: The easiest sharpness compensation, made possible by asymmetrical swing/tilt axes

In terms of technical capabilities, the Sinar p2 camera represents the leading edge of today's camera technology. It gives the photographer purposeful adjustment capabilities that are based on well thought out and very precise mechanisms. That precision and the sturdiness is particularly important when a digital back is being used. With the asymmetrical swing/tilt axes, sharpness compensation can be accomplished swiftly and with great accuracy.

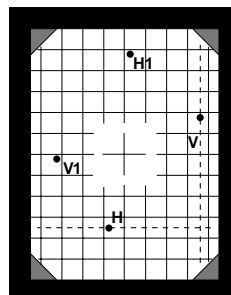

Even with double sharpness compensation, the camera always remains in the correct position (free of sway), there is no need for tilting anything out of the way or for any readjustments.

1. An image point is focused on the horizontal (H) or the vertical (V) swing/tilt axis.
2. Now focusing is performed on the other axis, i.e. over the entire image area, using the fine drive knob, and presto: it is done! If necessary, the inclination obtained in this manner with the swing/tilt axis can be transferred to the front standard in order to retain the same perspective.

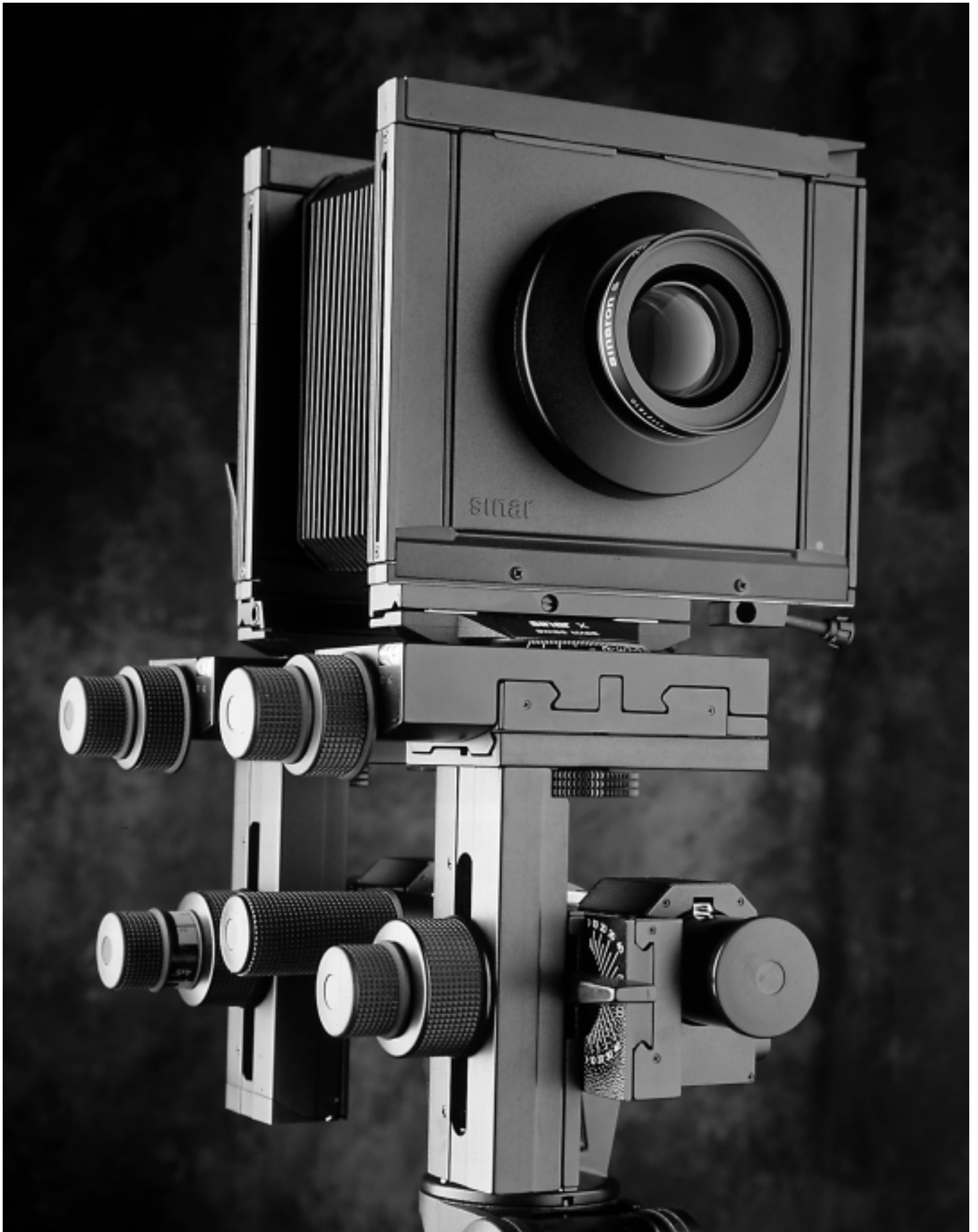

The Sinar x

SINAR x 4x5"/10x12.5 cm

491.66

Consists of:

- 411.21 Rail Clamp 1
- 422.21 Basic Rail 12"/30 cm
- 429.21 2 Rail Caps
- 431.71 Front Standard x
- 433.76 Rear Standard x 4x5"/10x12.5 cm
- 454.11 Multipurpose Bellows 4x5"/10x12.5cm
- 461.36 Holder/Focusing Back 4x5"/10x12.5 cm
- 531.41 Lensboard Holder

Weight: 5.8 kg (13lb).



Adjustment ranges:

Adjustment	
vertical:	↑ 4 cm, ↓ 4 cm
horizontal:	← 3 cm, → 5 cm
Coarse tilt:	± 40°
Fine tilt:	± 19°
Swivel:	± 50°
Fine focus:	5 cm
Bellows extension with	
Multipurpose bellows:	4 cm to 45 cm



The Sinar x: A cost-efficient high-end view camera

For studio photography in the 4x5" format, the Sinar x camera is a cost-efficient alternative to the outstanding Sinar p2 camera, performing all the functions with equal perfection, but deliberately dispensing with some of the operating amenities.

The TTL Metering Back, for instance, is not included in the basic outfit, but it remains an option that can be added later. As in the Sinar p2 camera, all fine drives are self-locking, so that a separate locking device is unnecessary, significantly enhancing focusing accuracy. All that is needed is a slightly stronger turning motion than that required for adjusting the Sinar p2 camera.

The feature of adapting formats larger than 4x5" was also intentionally fore-

gone on the Sinar x camera. Modern digital backs with area CCD arrays, such as the Sinarback or the Leaf Volare, for instance, as well as digital camera scanners, can also be used without any problems on a Sinar x camera.

The asymmetrical swing/tilt capability for fast, optimal and accurate setting of the plane of sharpness is, of course, an integral feature of the Sinar x camera. As in every Sinar camera, finish and workmanship are perfect to the last detail, ensuring outstanding durability and value retention. The Sinar x camera provides the large format photographer with the best features at a favorable price: it is the perfect entry camera and it can be expanded at will within the Sinar modular system.

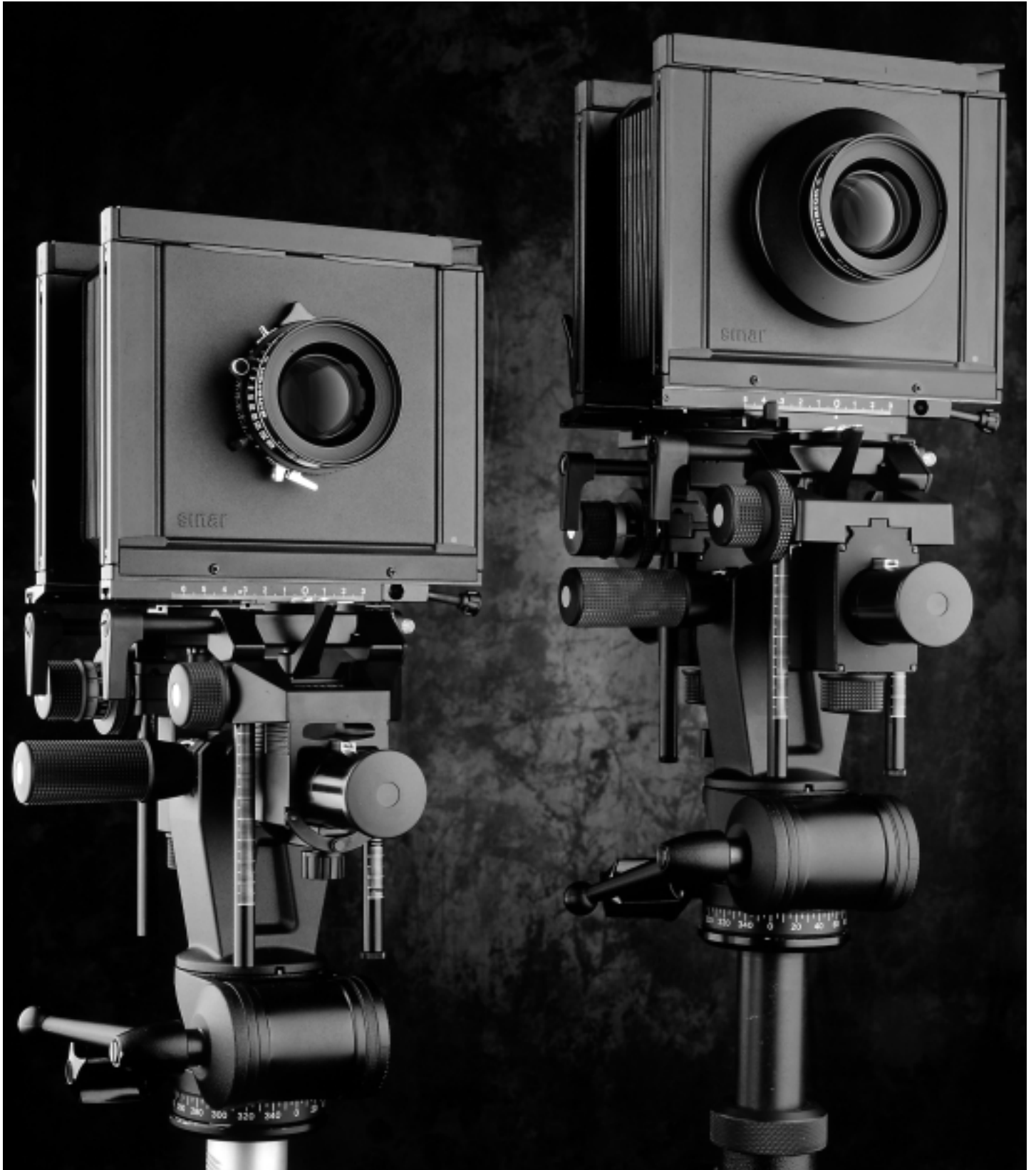

The Sinar f2

SINAR f2 4x5"/10x12.5 cm

491.96

Consists of:

- 411.21 Rail Clamp 1
- 422.21 Basic Rail 12"/30 cm
- 429.21 2 Rail Caps
- 431.61 Front Standard f2
- 433.66 Rear Standard f2 4x5"/10x12.5 cm
- 454.11 Multipurpose Bellows 4x5"/10x12.5 cm
- 461.36 Holder/Focusing Back 4x5"/10x12.5 cm
- 531.41 Lensboard Holder

Weight: 3.6 kg (8 lb)



Adjustment ranges:

Vertical adjustment: \updownarrow 11 cm

Horizontal adjustments

Rear standard: \leftarrow 4 cm, \rightarrow 2 cm

Front standard: \leftarrow 5 cm, \rightarrow 3 cm

Coarse tilt: \pm 40°

Swivel: \pm 50°

Fine focus: 4 cm

Bellows extension with

Multipurpose bellows: 4 cm to 45 cm



Sinar f2: Expansion is possible at any time

A special characteristic of the Sinar f2 is its light weight, which makes it an ideal large format camera for assignments that require travel. Because of its attractive price, it also enables young photographers to embark on the Sinar System. If the camera is later converted into a Sinar p2, the components of the Sinar f2 can continue to be used as practical accessories within the Sinar Modular System.

The Sinar f2 is the most basic version. Nevertheless, with its angle scale dial and its depth of field scale, it already possesses the most important features for simple camera adjustments.

The front standard can be used as an intermediate standard after an expansion. Its rear standard is not equipped to accommodate the metering probe. Both, the front and the rear standard feature fine focusing knobs for precise sharpness control. In addition, the Sinar f2 can be equipped with a metering back as an accessory that makes it possible to use a metering probe at the film plane. This system of compatible components allows a gradual expansion of the camera outfit, beginning with the most basic f2, progressing all the way to a p2.

The Digital Image

The change from chemical to digital imaging in professional photography took place quicker than originally imagined: The image is recorded with a digital storage medium and fed directly into a computer for further manipulation. Even though digital imaging technology is unlikely to replace film for very high resolution photography completely, today it is established in practically all segments of photography, including still life photography, catalog- and fashion photography. Even with moving subjects there are no limitations any more.

Basically, there are two different kinds of digital backs that can be used on a Sinar camera:

● **Digital backs with a CCD sensor array:** Because of the short exposure times, basically all the usual light sources can be used (flash or continuous lighting). The relatively small CCD chip requires lenses with short focal lengths that must also have very high resolution. The Sinar product range now includes the special Sinaron Digital lenses that are capable of transferring the complete image information to the high pixel density of the CCD chip. Exposure parameters and color filtering are controlled in different ways, depending on the type of digital back that is being used (one- or multi-shot). For example, the Sinarcam 2 is used with the Sinarback (1- and 4-shot), whereas the Sinarcam 1 is used with the Leaf Volare (3-shot). But there are also digital backs with which one of the versions of the Sinar Expolux shutter is used.

● **Digital backs with a camera scanner:** These scanners have three tightly aligned CCD arrays for the basic colors red, green and blue, so that only one scanning pass is required per exposure. Scanning takes a few minutes, therefore only continuous light can be used, such as halogen light, calibrated fluorescent light with daylight color balance or HMI light.

For professional imaging, the following **computer** requirements apply: Apple Macintosh Power PC with OS 8.5 or higher, at least 256MB RAM, graphic card with at least 4MB VRAM (true color rendition), hard disk drive with at least 1 GB available storage space, 17" or larger monitor, CD drive, output devices for filing and data exchange, such as a CD writer, Iomega Jaz or Iomega Zip interchangeable discs, Digital Versatile Discs (DVD), etc. If electronic image manipulation is also to be performed on the same computer, a faster processor is recommended, along with a 20" (or larger) monitor and greater memory capacity.

For the very best results with both imaging techniques, the highest demands are also placed on the camera and on the lenses. The cameras we recommend are the Sinar p2 as well as the Sinar x, which are well suited for this purpose, because of their precise adjustment capabilities and their sturdiness.

The compact studio cameras from Sinar are excellent choices for highly efficient work in regular studio photography:

● The **Sinarcam 2** with the Sinarback Digital Back can be used as a compact studio camera and it can also be used in conjunction with the Sinar p2 (Sinar x) view cameras. These combinations produce high-quality color photographs of static subjects (4-shot) and also of dynamic subjects (1-shot).

● The **Sinarcam 1** with the Leaf Volare or the Leaf DCB-LV digital back can also be used as a compact studio camera and it can also be used in combination with the Sinar p2 camera system. Static subjects can be photographed in high-quality color and dynamic subjects can be captured in black-and-white. Upon request, also for Leaf 1-shot digital backs, the Sinarcam 3 is available (same as the Sinarcam 1 but without the filter wheel).

For the compact versions of Sinar Digital Cameras, there is a special **line of Sinaron Digital lenses** designed for uncomplicated, efficient studio photography. The basic lens in that line is the 35–80 mm *f*/2.8 Sinaron Digital Zoom Lens. In addition, lenses from Leica, Nikon, Olympus, Hasselblad and Mamiya can also be used, thus creating the broadest selection of lenses for a digital camera system. For professional Sinar Digital Cameras, Sinar offers the line of Sinaron Digital Lenses in DB Auto Aperture Mounts.



Today, the Sinarback digital back on the Sinarcam 2 and the Sinar p2 are the ultimate professional working tools in the digital photography studio.



Digital photography not only produces detailed image information that can be utilized immediately, it also permits direct and exact controls of numerous parameters right on the monitor.

Everything from the same source

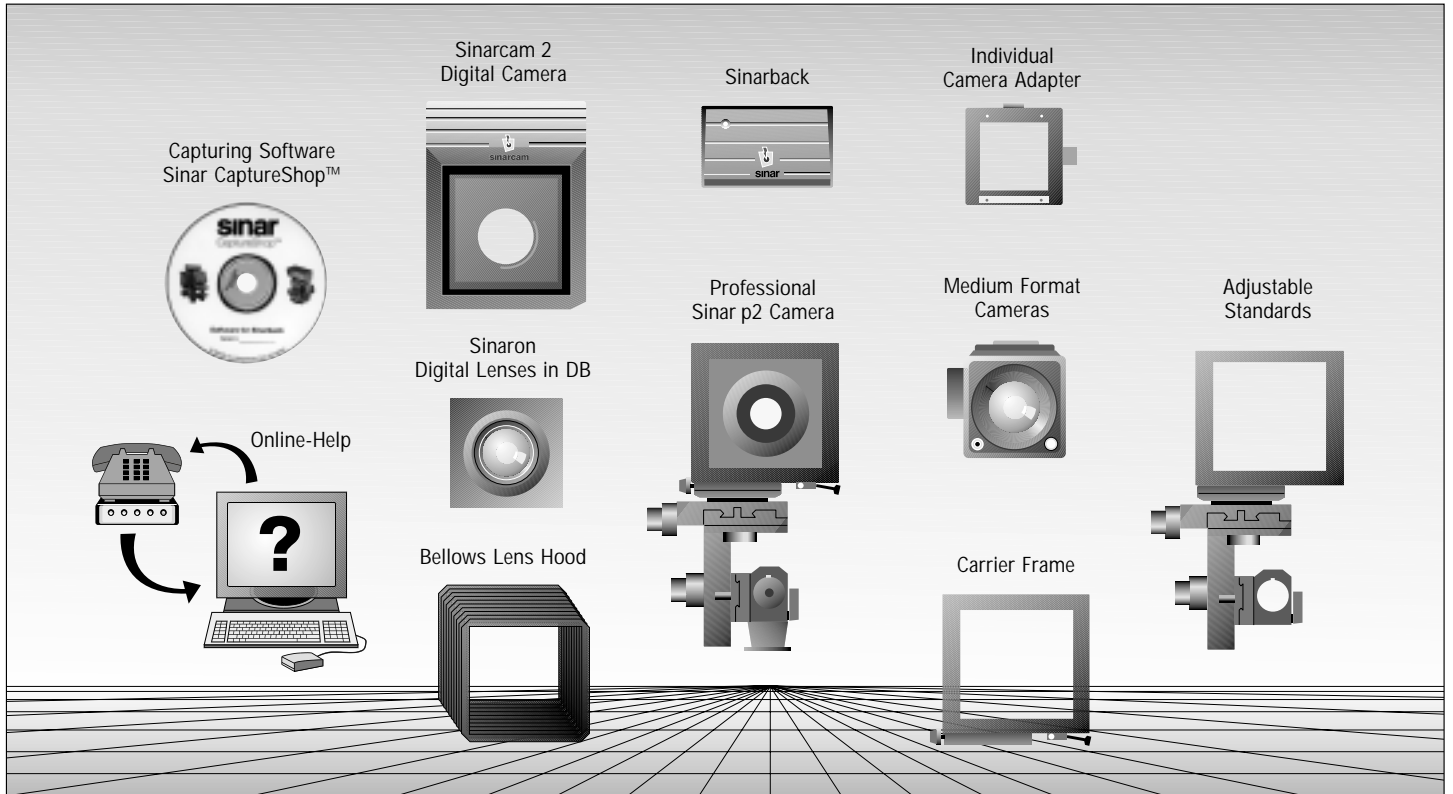

Digital imaging techniques are becoming ever more important in photography. In certain categories, professional photographs made digitally have already surpassed those made with chemical film. The know-how and the skill of the photographer continue to be as indispensable as they were before. Optical and physical imaging requirements remain unchanged. As before, it is important for the photographer to select the camera that is most appropriate for the respective task. Today Sinar offers a digital imaging system for demanding studio photography that integrates seamlessly into its proven Sinar view camera system and that can also be attached to medium format cameras: the Sinarback.

Upgrading and the continued use of existing, well-proven accessories for the Sinar system are also safeguarded in digital photography. This open system constitutes an ideal foundation for the future as well. For chemical or for digital imaging media, Sinar offers precisely the right adaptations for its view cameras. In addition, the Sinarback can easily and quickly be attached to a medium format camera. Thanks to the live-video focusing image, it is also readily possible to adapt the Sinarback to a Sinarx or a Sinarf camera. This provides the pho-

tographer with the greatest possible freedom in the choice of the right camera for the respective photographic task.

With the Sinarcams and the Expolux shutter system, Sinar offers a solution for practically all applications in the field of view cameras. Even with scanner camera applications, for example, the Expolux shutter is

Computer requirements for professional digital imaging:

Apple Macintosh Power PC with OS 8.5 or higher, at least 256 MB RAM, graphic card with at least 4 MB VRAM (true color rendition), hard disc with at least 1 GB of available storage space, 17" or larger video monitor, CD drive, output devices for filing and data exchange, such as a CD writer, Iomega Jaz or Iomega Zip interchangeable discs, Digital Versatile Discs (DVD), etc. If electronic image manipulation is also to be performed on the same computer, a faster processor is recommended, along with a 20" (or larger) video monitor and greater memory capacity.

the ideal tool, regardless of whether continuous illumination or flash light is being used. The Sinarcams can be used as computer-controlled cameras on the Sinarp2 view camera and they can also be used on their own as compact solutions. With its fully automatic shutter- and aperture controls, the Sinarcam lets the photographer work where he can best devote himself to the composition and the exposure of the photograph: behind the camera, at the screen. Furthermore, it permits the use of a wide range of 35 mm, medium- and view camera lenses. This also makes it possible to use digital photography in extreme wide-angle situations.

The relatively small CCD area sensors used in digital photography require especially high precision in focusing the image in order to achieve optimal sharpness. Sinar cameras are well equipped for these requirements, at the same time offering the greatest ease of operation. In the field of digital photography too, Sinar remains faithful to its policy of providing the highest quality and efficiency, at the same time enabling you to obtain everything from the same trusted source.



Sinarcam 2/Sinarback

Sinarback

The universal, high-resolution **Sinarback** Digital Back developed by Sinar enables all Sinar view cameras as well as a variety of medium format cameras to be efficiently integrated into a demanding digital workflow. The Sinarback requires no filter wheel, yet every pixel contains full color information at a color depth of 14 Bit. The Sinarback can be used as a 4-shot camera for static subjects and as a 1-shot camera for dynamic subjects. Thanks to fiber optics technology, even picture sequences of at least one image per second are possible. The active and regulated cooling of the CCD chip minimizes electronic threshold noise, thus providing improved detail rendition, even in shadow areas.

The **Sinar CaptureShop™** imaging software especially developed for the Sinarback is user-friendly and has clear operating elements based on Photoshop. The settings of all the parameters for the exposure and for image data export as well as the operation of the Sinarcam 2 (aperture, shutter speed) can conveniently be made with the mouse.

The latest version of the software and of the operating instructions as well as tips & tricks can be found and downloaded from our website www.captureshop.com.

Easy adaptation to professional cameras

● The **Sinarback with Sinarcam 2 on a Sinar p2** is the perfect adjustable digital camera for professionals. The sturdy Sinar p2 with its many sophisticated focusing aids is recognized as a leading camera system in modern digital studios. It facilitates work, both with complex focusing in tabletop projects, as well as in the secure choice of croppings with packshots: with the Sinar p2 everything is under smooth control.

But only with the Sinarcam 2 does the Sinar p2 achieve its full potential. Live color video focusing image, vibration-free electronic shutter functions and automatic aperture control are but a few of its many features. The latter also permits the use of proven high-resolving power, apochromatically corrected Sinaron Digital lenses in DB auto-aperture mounts.

For applications that generate very large amounts of data (posters, reproductions of artworks, etc.), the photographer can avail himself of the **Macroscan** option.

● With only a few hand moves, the view camera version can be converted into a

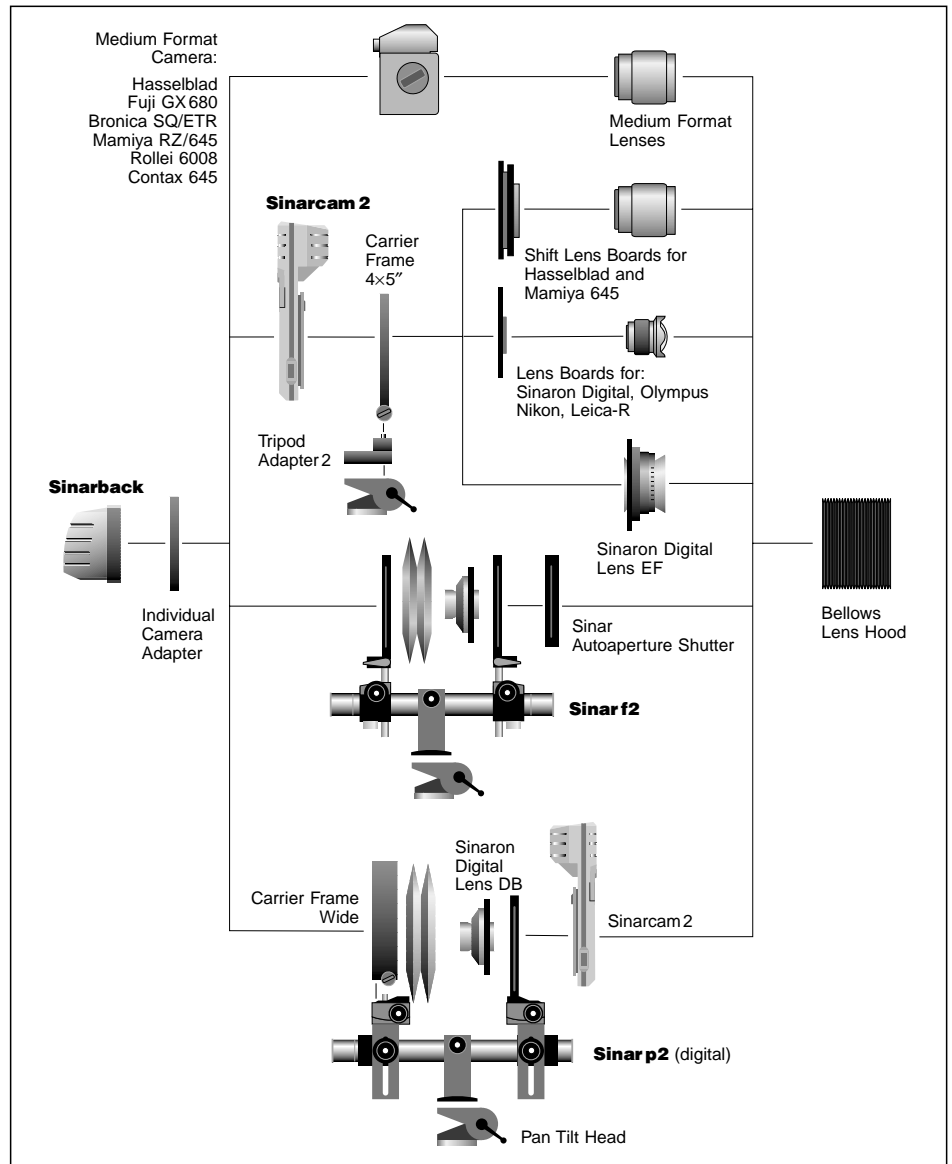

compact digital studio camera: the **Sinarcam 2 Compact** – a perfect camera for packshots, catalog productions and for any application that requires the highest image quality without camera movements. The pixel-accurate, live color video focusing image is also preserved. Lens adapter boards are available, so that a great variety of lenses can be used, like Sinaron Digital, Leica R, Nikon, Olympus, Hasselblad and Mamiya 645. The Sinarcam 2 Compact is a high-performance camera for mass high-quality productions.

● Mounting the **Sinarback directly on a Sinarf2 camera** creates a cost-efficient digital view camera. There are a few con-

veniences that will not be available, such as the live color video focusing image for instance, and the lens will have to be stopped down slightly while focusing in bright ambient light for exposures in the 4-shot mode.

● By means of adapter kits, the Sinarback can also be used on **medium format cameras** with removable film magazines, for instance on Hasselblad, Mamiya RZ 67 and 645, Fuji GX 680, Rollei flex 6008, Zenza Bronica SQ and ETR as well as Contax 645 AF cameras. Here too, the live color video focusing image is a standard feature.



Sinarcam 1

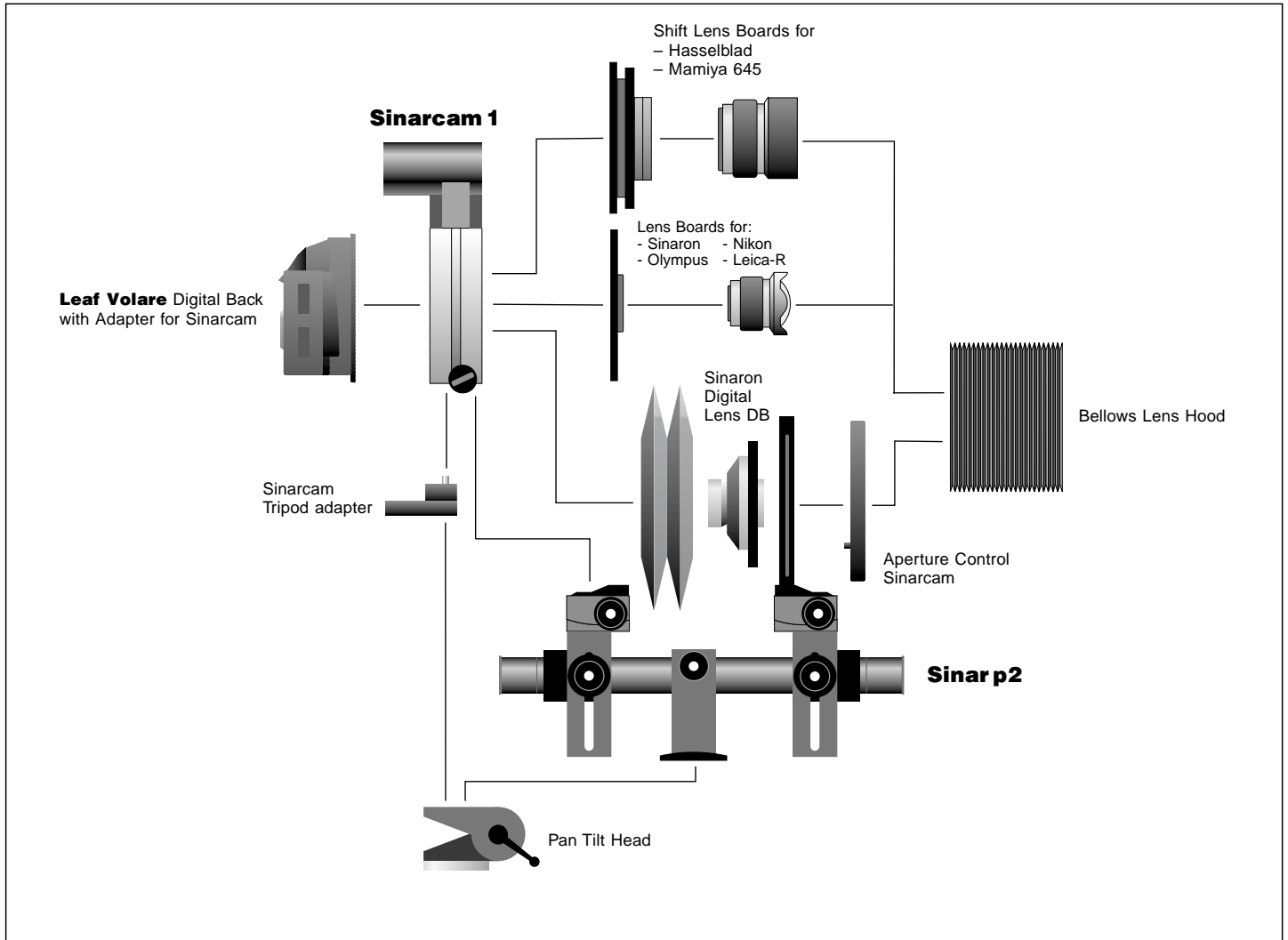

Sinarcam: The uncompromised Digital Camera

The Sinarcam 1 combines a digital adapter for the Sinar view camera system and a complete, compact digital studio camera in a single versatile unit. The focusing image can be viewed on the computer monitor as a high-resolution live-video image of any desired size. In combination with the Leaf Volare digital back, the Sinarcam 1 becomes a high-grade digital studio camera for all kinds of still life images with flash, continuous-, or mixed illumination. Its universal adaptability features the possibility of quickly and easily converting the compact camera into a professional camera (by attaching it to a Sinar p2 Camera). The adaptation principle of the Sinarcam permits the attachment of lenses from a

great variety of manufacturers. In addition to the special Sinaron Digital lenses in DB mounts (with the Sinar p2 view camera), the Compact version of the camera can also be used with lenses from Nikon, Olympus, Leica R, Hasselblad and Mamiya 645. Hasselblad and Mamiya lenses used for this purpose are mounted on a special shift board that provides the compact version of the Sinarcam with the capability of perspective correction.

The Leaf Volare Digital Back produces images with a resolution of 3,072 x 2,048 pixels at a color depth of 14Bit per color (16,384 gray tones). Thanks to the HV-Twist, the image format can be changed from a vertical to a horizontal format with a

single hand motion, without having to detach the digital back. The optional Color Shop software expansion is already incorporated in the imaging software and it can be activated by means of a hardware key (dongle). This software makes professional quality color separations possible with all the corrections that are necessary for that purpose (color, scaling, unsharp masking).

Additional information about the Sinar Digital Program is featured in a separate digital catalogue entitled "Sinar Digital Performance".

Each Item fits another



Sinar professional cameras of the latest generation are fully compatible with most of their older predecessor models. Our objective is to remain true to the policy of system conformity that we have already been practicing for more than 50 years. The investment made by a photographer is to retain its value. This consistency is unique to Sinar cameras. The multiple applications of individual system components significantly increase their utility to the user. Another characteristic Sinar feature! Two examples: the Multipurpose Bellows is useful not only as a camera bellows but also as a lens hood. The Wide Angle Bellows fits the binocular magnifier exactly to serve as a light hood, and so forth. The system components can always be used in new combinations. That is what makes a Sinar camera highly adaptable to a very large variety of photographic tasks.

Quick and easy format change

The Format Changing Set, which consists of a metering back, a carrier frame and a bellows, a Sinar p2 camera can be converted to various different film formats. Fast and with equal precision all the way to the "king size" 8 x 10"/20 x 25 cm or for attach-

ing a digital back, such as the Sinarback, Leaf Volare, etc. That makes a single Sinar camera suitable for use with all film sizes from 4.5 x 6 cm (Rollfilm Holder Zoom 2) all the way to 8 x 10"/20 x 25 cm without any restrictions. Whether rollfilm or sheet film, a choice the photographer must make based on the nature of the assignment and the application of the photographs, maximum advantage can be taken of a technical large format camera: manipulating perspective, either to correct it or to make it more dynamic; sharpness compensation, selective focus, etc.

Practical accessories for long bellows extensions

Very often long focal lengths or close-up photographs require long extensions. Such extensions cannot be achieved without accessories. But with a Sinar camera, this is easy. Many parts, such as the Rail Clamp, can be used universally. Thus the extension is quick and easy to set up in conjunction with a Multipurpose Standard. A practical accessory is the additional base plate.

The existing Basic Rail, however, can also be lengthened at will: extensions are available in lengths of 15, 30 and 45 cm (6", 12"

and 18"), which can be attached to either end of the Basic Rail in any combination. A Sinar camera grows with every assignment, no part becomes superfluous. And there is another important feature: unlike other base rails that extend telescopically, the Sinar Basic Rails preserves the stability of the camera.

Focusing Aids to suit the task

Depending entirely on personal preferences and on the nature of the assignments, a variety of focusing aids is available for evaluating the image on the focusing screen. Sinar offers several practical solutions. The basic binocular magnifier and the binocular reflex magnifier show the image magnified by a factor of 2. The binocular reflex magnifier produces a right-side-up image. Either the Multipurpose Bellows or the Wide Angle Bellows can be used as a light hood bellows with the simple binocular magnifier. Therefore the acquisition of a new bellows is not necessarily essential. The Sinar 4x Magnifier is very suitable for judging sharpness on the focusing screen, and it can also be used to evaluate original artwork or reflection copy.

Rail Units

BASIC RAIL 12"/30 cm

422.21

As many extensions as desired can be attached to either side (black end) of a basic rail, but it cannot be used as a rail extension itself. The 12"/30 cm Basic rail is supplied with every Sinar camera.



RAIL EXTENSION 6"/15 cm

421.21

RAIL EXTENSION 12"/30 cm

423.21

RAIL EXTENSION 18"/45 cm

424.21

For lengthening the optical bench by 6"/15 cm, 12"/30 cm or 18"/45 cm, respectively. As many extensions as desired can be attached to the red end.

- With the Special Rail Cap 428.31, these rail extensions can also be used as basic rails.



RAIL CAP

429.21

End caps for Basic Rail 30 cm (12") 422.21 and for the long Basic Rail 90 cm (36") 425.21, as well as for the red ends of rail extensions. Prevents unblocked standards from sliding off the rails.



SPECIAL RAIL CAP

428.31

Prevents unblocked standards from sliding off the rail when rail extension 423.21 or 424.21 is being used as a basic rail.



On all Sinar cameras and components (except for film holders), the format designation 4 x 5"/10 x 12.5 cm includes the 9 x 12cm (3 1/2 x 4 3/4") film size, and the 8 x 10"/20 x 25 cm designation includes the 18 x 24 cm (7 x 9 1/2") film size.

Standards

<p>FRONT STANDARD p2 431.51</p>	<p>Lens standard for the Sinar p2 with shift mechanisms and asymmetrical swing and tilt capabilities. Equipped with self-locking fine adjustment drives and designed for ergonomic operation.</p> <ul style="list-style-type: none"> ● Special Front Standard p2 431.52 is recommended when the 8x10"/20x25 cm format is used frequently.
<p>SPECIAL FRONT STANDARD p2 431.52M</p>	<p>Lens standard for the Sinar p2 8x10"/20x25 cm with shift mechanisms and asymmetrical swing and tilt capabilities. Equipped with self-locking fine adjustment drives and designed for ergonomic operation. Zero settings tailored specifically to the 8x10"/20x25 cm format.</p> <ul style="list-style-type: none"> ● This lens standard also permits greater vertical shifts than Lens Standard p2 431.51. Special Bearer p2 433.52 is recommended for use in conjunction with this format.
<p>BEARER p2 433.51</p>	<p>Lower portion of the rear standard of the Sinar p2, with shift mechanisms, asymmetrical swing and tilt capabilities and a depth of field scale. Equipped with self-locking fine adjustment drives and designed for ergonomic operation. Depending on the format being used, Carrier Frames 4x5"/10x12.5 cm, 5x7"/13x18 cm or 8x10"/20x25 cm (433.26/.27/.58), or correspondent digital adapters (see separate print "Digital Performance") can be mounted on this bearer.</p> <ul style="list-style-type: none"> ● The use of this bearer (in conjunction with the appropriate carrier frame) in place of a regular Sinar f2 Rear Standard, can significantly increase the ease of operating a Sinar f2 Camera because of the asymmetrical swing and tilt capabilities. ● Special Bearer p2 433.52 is recommended when the 8x10"/20x25 cm format is used frequently.
<p>SPECIAL BEARER p2 433.52</p>	<p>Reinforced lower portion of the rear standard of the Sinar p2 with shift mechanisms, asymmetrical swing and tilt capabilities, greater shifting displacements and a depth of field scale for the 8x10"/20x25 cm format.</p> <ul style="list-style-type: none"> ● Can also be used with 4x5"/10x12.5 cm and 5x7"/13x18 cm formats.
<p>CARRIER FRAME 4x5"/10x12.5 cm 433.26</p>	<p>Upper portion of the rear standard of the Sinar p2 and the Sinar e 4x5"/10x12.5 cm. Fits on Bearer p2 433.51, Special Bearer p2 433.52, Bearer e 433.11 and Special Bearer e 433.12.</p> <ul style="list-style-type: none"> ● Also available for the larger formats of Sinar p2 and Sinar e Cameras: for 5x7"/13x18 cm 433.27, for 8x10"/20x25 cm 433.58



sinar System Components

FRONT STANDARD x

431.71

Lens standard of the Sinar x with shift mechanisms and asymmetrical swing and tilt capabilities. Equipped with self-locking fine adjustment drives and designed for ergonomic operation.



REAR STANDARD x 4x5"/10x12.5 cm

433.76

Rear standard of the Sinar x with shift mechanisms, asymmetrical swing and tilt capabilities and a depth of field scale. Equipped with self-locking fine adjustment drives and designed for ergonomic operation.

- The use of this rear standard in place of the regular Sinar f2 Rear Standard can significantly increase the ease of operating a Sinar f2 Camera because of the asymmetrical swing and tilt capabilities. The original Sinar f2 Rear Standard can continue to be used as an auxiliary standard.
- This rear standard accepts Holder/Focusing Back 4x5"/10x12.5 cm 461.36.



MULTIPURPOSE STANDARD 4x5"/10x12.5 cm

437.61

This is the most frequently used standard for supporting a professional bellows lens hood. It also serves as an intermediate support for long bellows extensions, or as an object stage and a holder for the Sinar Color Control Filter System and for Sinar mirrors, etc. Has shift, swing and tilt capabilities.



MULTIPURPOSE STANDARD 5x7"/13x18 cm

437.62

Intermediate standard for long bellows extensions with the 8x10"/20x25 cm format. Multipurpose standard for a professional bellows lens hood for formats larger than 4x5"/10x12.5 cm. Equipped with shift, swing and tilt mechanisms.

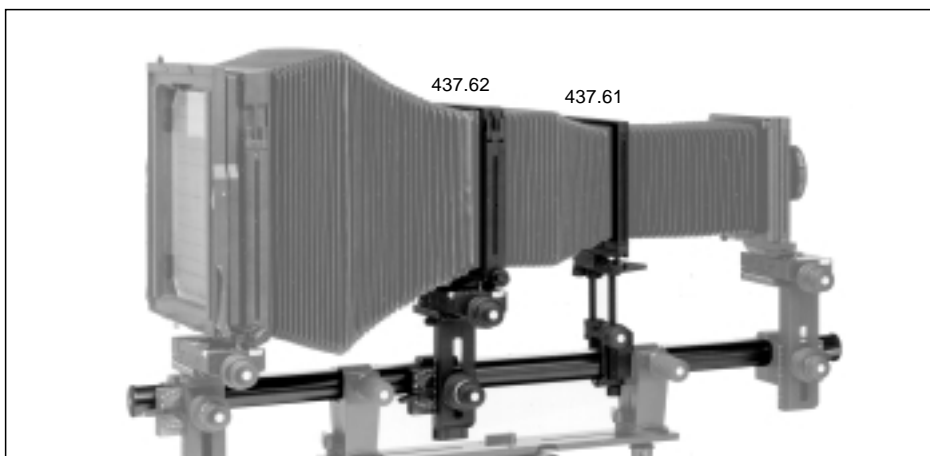

sinar System Components

METERING BACK 4x5"/10x12.5 cm

462.16

This metering back is used with Carrier Frame 4x5"/10x12.5 cm 433.26 of the Sinar p2 and with the rear standards of the Sinar x 433.76, the Sinar f2 and f1 (433.66 and 433.66.001, respectively). It consists of Metering Holder Frame 4x5"/10x12.5 cm 462.96, Focusing Frame 2 461.56 and Focusing Screen 536.66.

- Fresnel Lens 461.76 is recommended for focusing, especially with smaller formats of the Set of Formats 534.16.

- The probe housing of the metering holder frame accommodates any of the metering probes (Sinar Expolux Booster, Sinar Booster 1, Sinar FCM-Booster, Sinarsix-Digital, Profi-select TTL).

This metering back permits accurate metering of subject points without causing the image to become unsharp, as it would when a light meter cassette is inserted.



METERING BACK 5x7"/13x18 cm

462.17

This metering back is used with Carrier Frame 5x7"/13x18 cm 433.27 of the Sinar p2 and with Rear Standard 433.67 of the Sinar f2.

It is supplied with Focusing Screen 536.37.

- Fresnel Lens 535.17 is recommended.

- Equipped with a hydraulic damping mechanism that prevents the movable rear cover from closing abruptly when a film holder is removed, thus avoiding potential damage to the focusing screen.

Its other properties are equal to those of Metering Back 4x5"/10x12.5 cm 462.16 described above.



METERING BACK 8x10"/20x25 cm

462.58

This metering back is used with Carrier Frame 8x10"/20x25 cm 433.58 of the Sinar p2 and with Rear Standard 433.68 of the Sinar f2.

It is supplied with Focusing Screen 536.58.

- Fresnel Lens 535.58 is recommended.

Its other properties are equal to those of Metering Back 5x7"/13x18 cm 462.17 described earlier.



HOLDER/FOCUSING BACK 4x5"/10x12.5 cm

461.36

Holder and focusing screen without probe housing. Fits Carrier Frame 4x5"/10x12.5 cm 433.26 of the Sinar p2 and Rear Standard 433.76 of the Sinar x and 433.66 of the Sinar f2.

Consists of Holder Frame (without probe housing) 4x5"/10x12.5 cm 461.46 and Focusing Frame 2 461.56 with Focusing Screen 536.66.

- Fresnel Lens 461.76 is recommended for focusing, especially with smaller formats of Set of Masks 534.16.

- The use of an exposure metering probe (Sinar Booster 1 or Sinar Expolux Booster) requires Metering Back 4x5"/10x12.5 cm 462.16.



Focusing Aids

FRESNEL LENS **4x5"/10x12.5 cm**

461.76

Brightens the image on the focusing screen, making it considerably easier to view that image, especially with short focal length lenses. Format masks from Set of Masks 534.16 can be inserted in the fresnel lens holder without having to remove the fresnel lens.

Easy to snap into Metering Back 4x5"/10x12.5 cm 462.16 or into Holder/Focusing Back 4x5"/10x12.5 cm 461.36.



FRESNEL LENS **5x7"/13x18 cm**

535.17

FRESNEL LENS **8x10"/20x25 cm**

535.58

Features similar to those of the of Fresnel Lens 4x5"/10x12.5 cm 461.76.

The 535.17 (dimensions: 128x170 mm) fits in Metering Back 5x7"/13x18 cm 462.17 and in any 5x7"/13x18 cm Sinar Holder/Focusing Back.

The 535.58 (dimensions: 216x265 mm) fits in Metering Back 8x10"/20x25 cm 462.58.

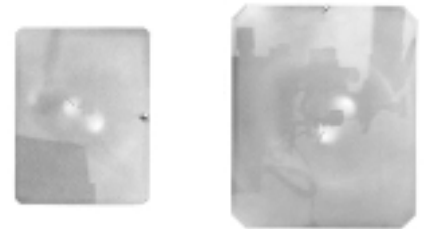

SET OF MASKS

534.16

Transparent yellow masks for outlining the image format on a focusing screen when several formats are being used. Fits in Fresnel Lens Frame 461.76.

Includes masks for 6x6, 6x7, 6x9 and 10x12.5 cm formats.



MAGNIFIER 4x

531.11.001

Aspherical color-corrected focusing magnifier with 4x magnification. Viewing area: 45 mm (1³/₄" \varnothing). Individual viewing sharpness can be adjusted with a focusing ring.

● Can be used for checking the image on a focusing screen and also for viewing color transparencies or reflection prints.



sinar System Components

BINOCULAR MAGNIFIER

471.21

Can be attached to any Sinar bellows with a 4x5"/10x12.5 cm frame for viewing the image on the focusing screen. With the magnifier swung in, the image on the screen is magnified 2x. In order to avoid false measurements, Binocular Light Hood 531.51 is required for shielding the focusing screen from extraneous light during TTL exposure metering.

- Joint Rod 472.51 is recommended for attaching the bellows.



BINOCULAR REFLEX MAGNIFIER 4x5"/10x12.5 cm

531.12

Permits viewing of a right-side-up image on the focusing screen with a choice of normal size or 2x magnification. The mirror is adjustable for best possible viewing of the image on the focusing screen. This is particularly important when it is being used in conjunction with a fresnel lens. Requires the use of Binocular Light Hood 531.51.

For farsighted persons, a Pair of Loupes with 4.25 Diopters 531.12.001 is available.



BINOCULAR LIGHT HOOD

531.51

For viewing the image on a focusing screen with Binocular Magnifier 471.21 or Binocular Reflex Magnifier 531.12 without the interference of extraneous light. Has a flap to prevent stray light from affecting the accuracy of TTL exposure measurements.



PAIR OF LOUPES 4.25 Diopters

531.12.001

For insertion into Binocular Magnifier 471.21 or Binocular Reflex Magnifier 531.12 as eyesight correction for farsighted persons. Special tools and instructions for installation are included.



Bellows

MULTIPURPOSE BELLOWS

4x5"/10x12.5 cm

454.11

Camera bellows for the 4x5"/10x12.5 cm Sinar f1, f2, x, p2 and e. Used with multipurpose standards for increasing the bellows extension for all formats and as a light hood for viewing the image on the focusing screen and also as a lens hood. The snap fit on its frame permits easy attachment to Filter Holders 1 or 2 (547.11 or 547.21 respectively). Maximum extension is 45 cm (18").



TAPERED BELLOWS

5x7"/13x18 cm

452.17

For extensions up to 50 cm (20") with the 5x7"/13x18 cm format. For longer extensions, an additional Multipurpose Standard 437.61 and a Multipurpose Bellows 454.11 are needed. Also serves as a light hood for viewing the image on a 5x7"/13x18 cm focusing screen.



TAPERED BELLOWS

8x10"/20x25 cm

452.58

For extensions up to 65 cm (25") with the 8x10"/20x25 cm format. Fits on Carrier Frame 433.58 and on 8x10"/20x25 cm Metering Back 462.58. For a further extension from 65 to 90 cm (25 to 35"), an additional Multipurpose Standard 437.61 and a Multipurpose Bellows 454.11 are needed.



SPECIAL BELLOWS

8x10"/20x25 cm to 5x7"/13x18 cm

453.58

For bellows extensions beyond 90 cm (36") with the 8x10"/20x25 cm format. A 5x7"/13x18 cm Multipurpose Standard and a 5x7"/13x18 cm Tapered Bellows are required as intermediate bellows support. Additional bellows extensions are possible by adding more multipurpose standards and multipurpose bellows.

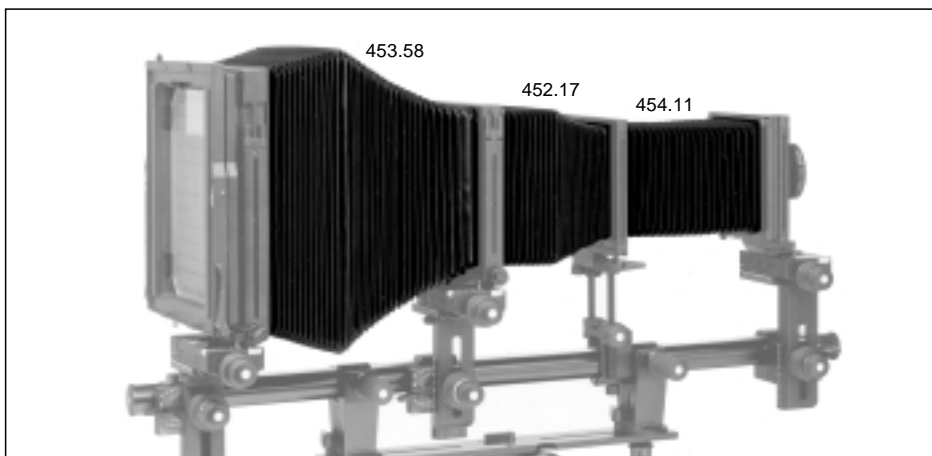

On all Sinar cameras and components (except for film holders), the format designation 4 x 5"/10 x 12.5 cm includes the 9 x 12cm (3 1/2 x 4 3/4") film size, and the 8 x 10"/20 x 25 cm designation includes the 18 x 24 cm (7 x 9 1/2") film size.

sinar System Components

WIDE ANGLE BELLOWS 1 4x5"/10x12.5 cm

455.36

For short bellows extensions with the 4x5"/10x12.5 cm format. For use with focal lengths from 75 to 135 mm focused at infinity. Good camera adjustment capability is retained in spite of the short extension.

- Also serves as a hood while viewing an image on the focusing screen, for example with Binocular Magnifier 471.21 and Binocular Light Hood 531.51.



WIDE ANGLE BELLOWS 2 4x5"/10x12.5 cm

455.46

This wide angle bellows is required for 4x5"/10x12.5 cm format photography in conjunction with extreme wide angle lenses (65 mm or shorter), for extreme camera adjustments and for digital photography with CCD array chips.



WIDE ANGLE BELLOWS 5x7"/13x18 cm

455.27

For very short bellows extensions with the 5x7"/13x18 cm format and focal lengths from 90 to 165 mm focused at infinity. Permits good camera adjustments in spite of the short extension.

- Can also be used as a focusing screen viewing hood, for instance with Binocular Magnifier 471.21 and Binocular Light Hood 531.51.



WIDE ANGLE BELLOWS 8x10"/20x25 cm

455.58

For very short bellows extensions with the 8x10"/20x25 cm format and focal lengths from 120 to 240 mm focused at infinity. Fits on Carrier Frame 433.58 and on Metering Back 8x10"/20x25 cm 462.58. Permits good camera adjustments in spite of the short extension.

- Can also be used as a focusing screen viewing hood with the 8x10"/20x25 cm format, for instance with Binocular Magnifier 471.21 and Binocular Light Hood 531.51.



Bellows Lens Hood

MULTIPURPOSE BELLOWS

4x5"/10x12.5 cm

454.11

Standard camera bellows for the Sinar f1, f2, x, p2, and e 4x5"/10x12.5 cm. Also serves as a bellows lens hood. The snap fit on its frame permits easy attachment to Filter Holder 1 or 2 (547.11 or 547.21, respectively).



MULTIPURPOSE STANDARD

4x5"/10x12.5 cm

437.61

Multipurpose standard for the professional lens hood. Equipped with shift, swing and tilt movements.



JOINTED ROD

472.51

Forms an adjustable bellows lens hood when used in combination with Multipurpose Bellows 454.11 (or with any Sinar bellows with 4x5"/10x12.5 cm frames) and two Bellows Holders 473.31. The Jointed Rod is equipped with two ball joints that can be locked in position. Extends to approximately 12"/30 cm.

- Can also be used for supporting a wide angle or multipurpose bellows as a focusing screen viewing hood.



ROD, SHORT, 4 1/4"/11 cm

472.61

ROD, MEDIUM, 6 1/4"/16 cm

472.71

ROD, LONG, 10"/25 cm

472.81

In combination with Multipurpose Bellows 454.11 (or with any Sinar bellows with 4x5"/10x12.5 cm frames) and two Bellows Holders 473.31, these rods form a basic bellows lens hood which, however, permits no camera adjustments.

- These rods are also used for supporting Swivelling Linear Polarizing Filter 546.31.
- The use of Jointed Rod 472.51 is recommended when camera adjustments have to be made.

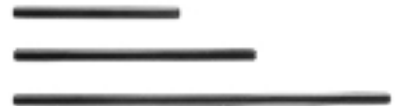

BELLOWS HOLDER

473.31

Used for attaching a bellows or Bellows Hood Mask 1 or 2 (533.11 or 533.21, respectively) to the camera. Requires the use of one of the rods 472.61, 472.71 or 472.81, or Jointed Rod 472.51.



sinar System Components

BELLOWS HOOD MASK 1

533.11

Bellows Hood Mask 1 can be used as a lens hood for wide angle lenses or as a mask holder for special effects. Fits on all Sinar 4x5"/10x12.5 cm standards and on Bellows Holder 473.31. Consists of two hinged and two sliding panels.



BELLOWS HOOD MASK 2

533.21

With four roller blinds with positioning scales controlled by separate fine adjustment drives, for precise vignetting control. Recommended for product shots, difficult backlit situations and multiple exposures. Fits on all Sinar 4x5"/10x12.5 cm standards, Bellows Holder 473.31, and on Filter Holder 1 547.11 or Filter Holder 2 547.21. Can be slipped on and rotated.



On all Sinar cameras and components (except for film holders), the format designation 4 x 5"/10 x 12.5 cm includes the 9 x 12cm (3 1/2 x 4 3/4") film size, and the 8 x 10"/20 x 25 cm designation includes the 18 x 24 cm (7 x 9 1/2") film size.

Bellows Lens Hoods

When a lens is used without a hood, stray light from outside the subject area can cause a noticeable reduction in contrast. A bellows lens hood, therefore, is not a luxury in professional photography, it is a requisite. But a bellows lens hood does its job only when it is properly adapted to the angle of view of the lens being used, and here the Sinar System offers several solutions.

The main part of the bellows lens hood is the multipurpose bellows. In the most basic case – when no adjustments have

been made on the camera – a multipurpose bellows can be attached to the lens standard with a simple rod and two bellows holders.

When the camera has been adjusted, the simple rod is replaced by a jointed rod. The most universal arrangement – especially when a filter holder is being used – is the use of one or more multipurpose standards, with which a bellows lens hood can be set up very accurately and with excellent stability.

The necessary additional room at the front of the optical bench can be obtained by attaching one of the three different rail extensions. Bellows Hood Masks 1 and 2 make it possible to control the limitation of the light path even in difficult situations. Bellows Hood Mask 2 also serves as a flexible viewfinder. Its adjustable blades permit the simulation of various picture proportions and focal lengths.



Format Changing

FORMAT CHANGING SET
4x5"/10x12.5 cm

497.26

For fast and easy conversion of a Sinar p2 5x7"/13x18 cm or a Sinar p2 8x10"/20x25 cm to the 4x5"/13x18 cm film format.

Consists of:

433.26 Carrier Frame 4x5"/10x12.5 cm

454.11 Multipurpose Bellows

462.16 Metering Back 4x5"/10x12.5 cm



FORMAT CHANGING SET
5x7"/13x18 cm

497.27

For fast and easy conversion of a Sinar p2 4x5"/10x12.5 cm or a Sinar p2 8x10"/20x25 cm to the 5x7"/13x18 cm film format.

Consists of:

433.27 Carrier Frame 5x7"/13x18 cm

452.17 Tapered Bellows 5x7"/13x18 cm

462.17 Metering Back 5x7"/13x18 cm



FORMAT CHANGING SET
8x10"/20x25 cm

497.58

For fast and easy conversion of a Sinar p2 4x5"/10x12.5 cm or a Sinar p2 5x7"/13x18 cm to the 8x10"/20x25 cm film format.

Consists of:

433.58 Carrier Frame 8x10"/20x25 cm

452.58 Tapered Bellows 8x10"/20x25 cm

462.58 Metering Back 8x10"/20x25 cm



FORMAT REDUCTION ADAPTER

From: 5x7"/13x18 cm

To: 4x5"/10x12.5 cm

553.27

Reduces the picture format from 5x7"/13x18 cm to 4x5"/10x12.5 cm without changing the carrier frame or the rear standard.

Requires the addition of Metering Back 4x5"/10x12.5 cm 462.16, or Holder/Focusing Back 4x5"/10x12.5 cm 461.36.

● The swing and tilt axes do not lie in the film plane, and wide angle camera adjustments are limited.



FORMAT REDUCTION ADAPTER

From: 8x10 /20x25 cm

To: 4x5 /10x12.5 cm

553.58

Use this format reduction adapter when you wish to make an inexpensive test shot on 4x5"/10x12.5 cm film instead of the more costly 8x10"/20x25 cm film, without having to refocus and without having to change the carrier frame or the rear standard.

Requires the addition of Metering Back 4x5"/10x12.5 cm 462.16, or Holder/Focusing Back 4x5"/10x12.5 cm 461.36.

● The swing and tilt axes lie in the film plane, and wide angle camera adjustments are not restricted.



Camera Supports

RAIL CLAMP 1

411.21

For the attachment of Sinar cameras to the Sinar Pan Tilt Head 516.41 or directly to the tripod. For greater stability with long bellows extensions, Clamping Adapter 411.21.010 is used for mounting these Rail Clamps on Base Plate 2 418.31. Fitted with a $\frac{3}{8}$ " tripod socket.

- Can be converted to a $\frac{1}{4}$ "-tripod socket with Reducing Bushing $\frac{3}{8}$ "- $\frac{1}{4}$ " 519.61.



RAIL CLAMP 2

411.41

For the attachment of Sinar cameras to the Sinar Pan Tilt Head 516.41 or directly to the tripod. For greater stability with long bellows extensions, Clamping Adapter 411.21.010 is used for mounting these Rail Clamps on Base Plate 2 418.31. Fitted with a $\frac{3}{8}$ " tripod socket.

- Can be converted to a $\frac{1}{4}$ "-tripod socket with Reducing Bushing $\frac{3}{8}$ "- $\frac{1}{4}$ " 519.61.
- Rail Clamp 2 has a 360° tensioning mechanism that ensures that the camera retains its horizontal position when the clamp is tightened.



CLAMPING ADAPTER

411.21.010

For mounting a Rail Clamp 1 or 2 on the Base Plate 2 418.31.

- Can also be used for quick attachment of Rail Clamp 1 411.21 or Rail Clamp 2 411.41 to Sinar Pan Tilt Head 516.41 by means of Quick Release Adapter 519.51.



QUICK RELEASE ADAPTER

519.51

For quick mounting of a rail clamp with clamping adapter or of a Base Plate 2 to Sinar Pan Tilt Head 516.41. Includes a $\frac{3}{8}$ " bolt.



BASE PLATE 2

418.31

The camera is mounted on the Base Plate 2 by means of two Rail Clamps 411.21 or 411.41, each equipped with a Clamping Adapter 411.21.010.

The Base Plate is attached to the Sinar Pan Tilt Head by means of a Rapid Clamping Adapter 591.51.



REDUCING BUSHING $\frac{3}{8}$ " - $\frac{1}{4}$ "

519.61

For the conversion of the standard $\frac{3}{8}$ " tripod socket thread from $\frac{3}{8}$ " to $\frac{1}{4}$ ". For use with: Pan Tilt Head 516.41, Rail Clamp 1 411.21, and Rail Clamp 2 411.41.



PAN TILT HEAD

516.41

Compact and stable Sinar Pan Tilt Head with a sturdy tensioning lever that can be positioned conveniently. Fitted with two positioning studs for fast and easy mounting of a rail clamp. Comes with a dual camera bolt $\frac{1}{4}$ " and $\frac{3}{8}$ ".

- The head can be smoothly rotated 360° horizontally for precise settings.



Other Accessories

SINAR ACCESSORY CASE

475.66

Designed for the safe transportation of a Sinar f2 4x5"/10x12.5 cm camera with an attached Sinar/Autoaperture behind-the-lens shutter or for use as a case for accessories.

Dimensions:

435 x 340 x 280 mm (17 x 13 x 11").

Weight when empty:

approximately 4.5 kg (10 lb).



SINAR CASE

475.26

Accommodates a

- Sinar p2 4x5"/10x12.5 cm or a Sinar x 4x5"/10x12.5 cm basic outfit or a
- Sinar f2 4x5"/10x12.5 cm basic or expert outfit, or a
- Sinar f1.

This case can also be used for safe storage of lenses, Sinar format adapters, Sinar exposure meters, etc.

Dimensions:

525 x 455 x 305 mm (21 x 18 x 12").

Weight (empty):

approximately 8 kg (17 lb 11 oz).



SINAR EXPERT CASE

475.42

The walls of this case are made of temperature-resistant high-density polyethylene to protect the camera during rough transportation (like air baggage handling or off-road travel). To ensure the safety of the camera and its accessories during transportation, the case is lined with an appropriate foam material that is custom-tailored to its contents.

The case is equipped with a full-length hinge, two rugged latches, loops for a padlock, three folding handles and four removable rollers.

It can hold the basic or the expert outfit of a:

- Sinar p2 4x5"/10x12.5 cm or Sinar p2 5x7"/13x18 cm or Sinar p2 8x10"/20x25 cm or
- Sinar f2 5x7"/13x18 cm or Sinar f2 8x10"/20x25 cm.

Additional accessories, like Sinar shutters, exposure meters, film holders, etc. can also be accommodated.

Dimensions:

640 x 500 x 380 mm (26 x 20 x 15").

Weight (empty):

approximately 11.5 kg (25 lb 6 oz).



DUST COVER

571.52

For the protection of camera set-ups indoors or outdoors.



Sinar System Components

Long, longer, longest ...

The long bellows extensions needed when lenses with extremely long focal lengths are used or when photographs are made in the macro range place particularly severe demands on the stability of the set-up. Fortunately the modular Sinar Component System provides practical solutions for every imaginable situation.

The backbone for long bellows extensions is the optical bench, which can be lengthened at will by adding rail exten-

sions of various lengths (see page 3-2). When a certain length is reached, additional support by means of extra rail clamps is recommended. A set-up with two rail clamps can then be supported by two pan tilt heads on two tripods, resulting in excellent stability. Even greater stability is achieved by mounting two rail clamps at a time on one common base plate and then using pan tilt heads to mount each base plate on a tripod.

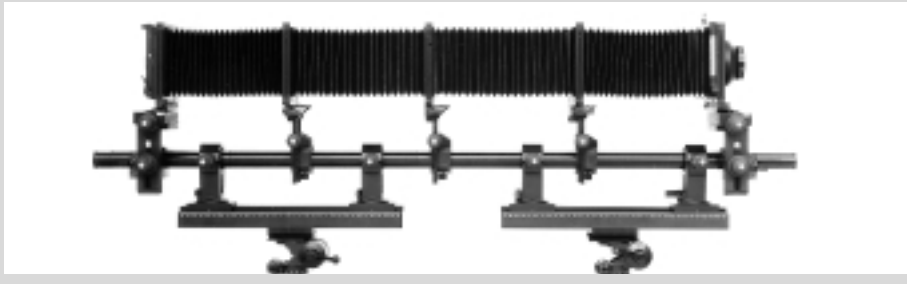

On all Sinar cameras and components (except for film holders), the format designation 4x5"/10x12.5 cm includes the 9x12cm (3 1/2 x 4 3/4") film size, and the 8x10"/20x25 cm designation includes the 18x24 cm (7 x 9 1/2") film size.

SEMI REFLECTING MIRROR 5x5"/12x12 cm

539.11

Sinar 50% semi reflecting mirror in a protective case. Helps to solve illumination problems in close-up photography. Serves to project a scene on a backdrop for front projection photography. Also useful for implementing many new ideas for special effects photography.
Mirror size: 5x5"/12x12 cm.
Fits on all Sinar 4x5"/10x12.5 cm standards.



HASSELBLAD CAMERA ADAPTER

556.64

Adapter board for attaching Hasselblad cameras to Sinar 4x5"/10x12.5 cm rear standards.
● Suited for lenses with focal lengths of 90 mm and more.



Basics and Applications Creative Large Format, Volume 1

More about the practical use of the Sinar camera and its versatile accessories can be found in the first volume of the book series "Creative Large Format". This competent book about fundamentals thoroughly informs you about the premises of modern large format techniques, the various camera adjustment possibilities, sharpness distribution, perspective correction and much more. Not only is this book excellent for newcomers to the world of large format photography, it is also a valuable reference volume for pro-

fessionals, who can find many a useful tip in it to further refine their skills. The volume on basics will be supplemented by a series of additional volumes, each one devoted to a particular subject. Already published:

- Volume 2, **Architectural Photography**
- Volume 3, **Natural Landscapes**
- Volume 4, **People Photography**
- Volume 5, **Advertising Photography**

Additional information about the Sinar Book Program can be found on page 8-2.



Sharp Eyes for Large Format Photography



The lens is a primary link in the quality chain that begins with the initial conception and ends with the printed page. Sinar supplies lenses under its own trademark Sinaron that are designed specifically for its camera system and manufactured by the Rodenstock Precision Optics Works. These lenses are subjected to strict inspection controls at Sinar and then mounted with exacting care on lens boards, either with between-the-lens shutters, or with automatic aperture control for the DB version of behind-the-lens shutters.

In lenses for 35 mm and for medium format photography, aperture is often regarded as a primary criterion, but in lenses for large format photography it is more the image circle on the focusing screen and the angle subtended by that image circle that matters. The larger that circle, the greater the freedom for camera adjustments. This becomes a decisive factor especially for the larger camera formats. The Sinar assortment of lenses includes the following types of lenses:

- **Sinaron-S Lenses:** Standard lenses that feature an enlarged image circle with an angle of view of 72°, which allows greater freedom for camera adjustments than conventional normal focal lengths that have an angle of view of only 53°.

- **Sinaron-SE Lenses:** This design represents state of the art technology, incorporating significant improvements over earlier comparable lens types in terms of image quality, especially in the close-up range. Stray light within the lens amounts to less than one percent, producing better contrast in the images. The angle of view subtended by its image circle was increased to 75°. Color correction was improved still further by the use of ED glass types.

- **Sinaron-W Lenses:** Professional lenses with an especially large image circle or angle of view of 100°. The six-element designs with focal lengths of 90, 115, 155 and 200 mm have a maximum aperture of f/6.8, and the eight-element designs with focal

lengths of 65, 75 and 90 mm have a maximum aperture of f/4.5. They produce a very bright focusing image with uniform illumination all the way into the corners.

- **Sinaron-WE Lenses:** These eight-element lenses with extremely short focal lengths have a picture angle of 110° at f/16 and they are available in DB Auto Aperture Mounts and also with a recessed plate and a Copal between-the-lens shutter. As is the case with Sinaron-SE lenses, their apochromatic correction ensures the highest imaging quality across the entire image circle. Sinaron-WE lenses are available with focal lengths of 45 and 55 mm, with a maximum aperture of f/4.5.

- **Apo-Sinaron Lenses:** When objects are to be reproduced in actual size, the Apo-Sinaron lenses are recommended for the best performance. Apo-Sinaron lenses are available with focal lengths of 240, 300, 360, 480 and 600 mm, all with a maximum aperture of f/9.

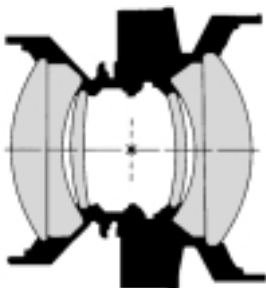

Sinaron-S

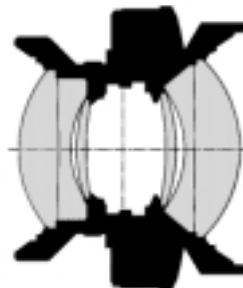

Sinaron-SE

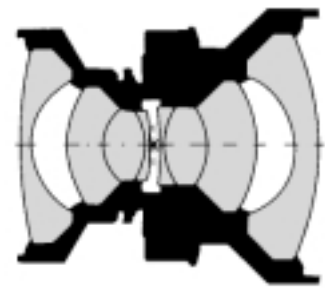

Sinaron-W

● **Macro-Sinaron Lenses:** The primary concern in close-up photography is not the image circle or angle of view, but image quality. The 180 mm Macro-Sinaron lens is optimally corrected for reproduction ratios ranging from 2:1 to 1:5.



Sinaron lenses are available in various versions and focal lengths. Auto Aperture (DB) is the standard mount for all Sinaron lenses.

● **Sinaron Digital Lenses:** Digital photography with CCD area sensors requires special lenses that are designed for optimal performance, in terms of focal lengths and resolution, with the small image format with a diagonal in the range of 35 to 55 mm. In order not to restrict camera adjustment capabilities, these lenses are mounted on the back of the lens standard, inside of the camera bellows.

Lenses supplied by Sinar are available in four different mounts. Auto Aperture Mounts DB, DBM and DBS offer the greatest ease of operation because of automatic aperture control, while Copal between-the-lens shutters are cost-efficient entry solutions on which all settings are manual.

● **Auto Aperture Mount DB:** Most convenient to operate, with automatic aperture control up to f/128 with the Sinar Expolux Shutter, and up to f/45 with the Sinar Auto Aperture Shutter. Existing lenses can be fitted with Auto Aperture Mount DB by means of the appropriate conversion kit. Auto Aperture Mount DB is the standard mount for all Sinaron lenses.

● **Auto Aperture Mount DBM:** In addition to its automatic function, this mount has

manual aperture settings for f-stops smaller than f/45. Existing lenses can be fitted with Auto Aperture Mount DBM by means of the appropriate conversion kit.

● **Auto Aperture Mount Special DBS:** Preserves complete wide angle camera adjustment capabilities, especially with the Expolux Shutter. Precludes any danger of vignetting by the shutter with 155 and 200 mm Sinaron-W lenses and with 165 and 210 mm Super Angulon lenses. Existing lenses can be fitted with Auto Aperture Mount DBS at the Sinar factory.

● **Copal between-the-lens Shutter:** Of course, Sinaron lenses can also be fitted with Copal between-the-lens shutters. It should be remembered, however, that every shutter functions within certain individual tolerances, which can manifest themselves as exposure variations in critical photographic situations when lenses are changed. One also has to do without the operating convenience provided by Sinar behind-the-lens shutters.

Full concentration on the photograph: The following procedure has to be observed when working with lenses equipped

with Copal between-the-lens shutters: The shutter and the aperture have to be opened manually for focusing. Just before the exposure is made, the shutter and the aperture have to be closed again by hand, the shutter has to be cocked and the shutter speed has to be set. Now everything is ready

for the actual exposure to be made. For checking the focus between exposures, the shutter and the aperture have to be opened and closed manually.

The procedure is different with lenses in (DB) auto-aperture mounts. Thanks to the automatic aperture and film holder features of Sinar behind-the-lens shutters (also see Chapter 5) the intermediate shutter manipulations are eliminated. The working aperture and the shutter speed are set at the beginning and the camera does the rest. The photographer is free to devote his full attention to the subject.

The quality chain – from camera to lens, filters, stray light protection, film holders, all the way to the film itself – is only as strong as its proverbial weakest link. Sinar has always strived to eradicate the weakest spots. Not only were all Sinar products rigorously reviewed to that effect, but stricter demands were also placed on suppliers of components. In recent years, advances in computerized lens design using new types of optical glass and in multiple coating techniques have led to significant improvements in the quality of lenses.

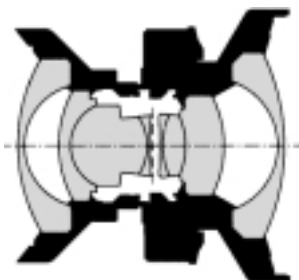

Sinaron-W



APO-Sinaron

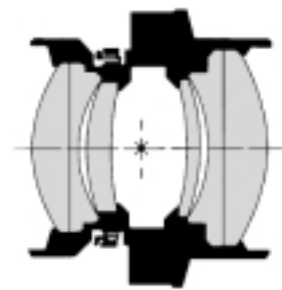

Macro-Sinaron

**SINARON LENSES IN
AUTO APERTURE MOUNTS (DB)
ON LENS BOARDS**

446.85. ...

Lenses fitted with Auto Aperture Mounts (DB) with automatic aperture control. The aperture is controlled automatically by behind-the-lens shutters Sinar Expolux 522.21.001, Sinar Auto Aperture 521.31 and Sinar Digital 522.11. This does away with time-consuming manual settings.



**AUTO APERTURE MOUNT (DB)
CONVERSION KIT
ON LENS BOARD**

446.75. ...

For do-it-yourself fitting of an existing lens with Auto Aperture Mount DB. Supplied complete with assembly instructions.

- When ordering, please provide accurate information about the brand, type, focal length and mount of the lens that is to be converted.



**SINARON LENSES IN
AUTO APERTURE MOUNTS
WITH MANUAL OVERRIDE (DBM)
ON LENS BOARDS**

446.86. ...

Same as 446.85. ..., but with added manual override (especially with apertures smaller than f/45 with the mechanical behind-the-lens shutter Sinar Auto Aperture Shutter 521.31).

- Not necessary for Sinar Expolux Shutter 522.21.001, because this shutter automatically sets apertures all the way down to f/128 (depending on the particular lens being used).



**AUTO APERTURE MOUNT WITH
MANUAL OVERRIDE (DBM) CON-
VERSION KIT ON LENS BOARD**

446.76. ...

For do-it-yourself fitting of an existing lens with an Auto Aperture Mount with Manual Override DBM that also works for apertures smaller than f/45 with the mechanical behind-the-lens shutter Sinar Auto Aperture Shutter 521.31. Supplied complete with assembly instructions.

- Not necessary for Sinar Expolux Shutter 522.21.001, because this shutter automatically sets apertures all the way down to f/128 (depending on the particular lens being used).
- When ordering, please provide accurate information about the brand, type, focal length and mount of the lens that is to be converted.



**SINARON LENSES IN SPECIAL
AUTO APERTURE MOUNTS (DBS)
ON LENS BOARDS**

446.81. ...

**SPECIAL AUTO APERTURE
MOUNT (DBS) CONVERSION KIT
ON LENS BOARD**

446.71. ...

Lenses fitted with Special Auto Aperture (DBS) Mounts and Conversion Kit for existing lenses, respectively. Permits the use of Sinar Expolux Shutter as a between-the-lens shutter. Prevents vignetting of large image circles with short focal lengths. The two parts of the DBS board are joined by a hinge. The lens standard with the shutter is placed between the two parts. Shortest exposure time: 1/8 sec. (except for 210 mm f/8 Super Angulon: 1/500 sec.) This Special Auto Aperture Mount (DBS) is suitable for the following lenses:

- 200 mm f/6.8 Sinaron-W
- 155 mm f/6.8 Sinaron-W
- 165 mm f/8 Super Angulon
- 210 mm f/8 Super Angulon

- Conversions and calibrations to be performed at the Sinar factory in Switzerland.



Technical details and order numbers for Sinaron lenses are listed in the tables on pages 4-5 to 4-7.

SINARON LENSES IN COPAL SHUTTERS ON LENS BOARDS

441.83. ...

Sinaron Lenses in Copal between-the-lens shutters. These lenses can also be used with a Sinar behind-the-lens shutter (see page 5-5).

- Subsequent conversion to an Auto Aperture Mount (DB) or (DBM) is possible at any time.



LENS BOARD READY TO MOUNT LENS

441.50. ...

With appropriate opening and tube for mounting assorted lenses, for use with between-the-lens shutters.

- When ordering a lens board, please provide accurate information about the type, focal length and mount of the lens to be mounted.

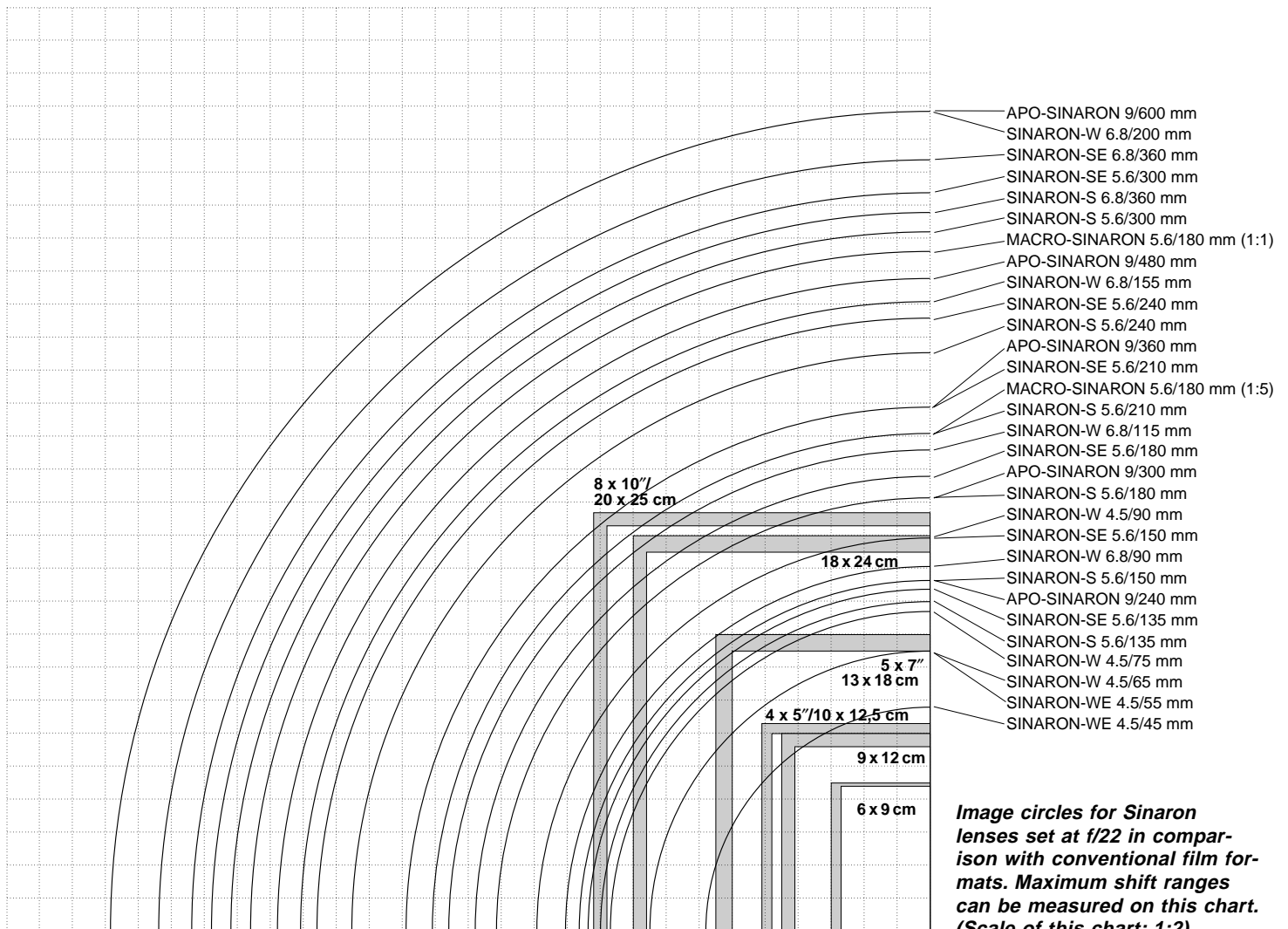

Sinar Lenses for Large Format Photography

Lens Type	1) Order Number (last 3 digits)	Focal Length in mm	Angle of View at f/22	Circle in mm at f/22	Smallest Aperture	6) Shutter Size (Copal)	Fitted with: ● = DB ■ = DBM ▲ = DBS	Conver- sion Kit: ● = DB ■ = DBM ▲ = DBS	Filter Thread (mm)	Mount Ø front/rear (mm)	Shift range in mm for horizontal format (for vertical format reverse the numbers)								Remarks	
											6x9cm		4x5"		13x18cm		8x10"			
											↔	↕	↔	↕	↔	↕	↔	↕		
Sinaron-S 1:5.6	558	135	72°	200	64	0	●	●	40.5 x 0.5	42 / 40.5	52	62	28	32	-	-	-	-		
	560	150	72°	214	64	1	●	●	49 x 0.75	51 / 42	59	70	36	41	2	3	-	-		
	562	180	72°	262	64	1	●	●	58 x 0.75	60 / 51	84	95	62	68	30	38	-	-		
	564	210	72°	301	64	1	●	●	67 x 0.75	70 / 60	104	116	83	90	52	63	-	-		
	566	240	72°	350	45	3	●	●	77 x 0.75	80 / 70	129	141	108	116	79	92	23	28		
	568	300	72°	425	64	3	■	■	86 x 1	90 / 80	167	180	147	156	118	134	67	77		
	570	360	64°	435	64	3	■	■	105 x 1	110 / 80	172	185	152	161	123	139	72	83		
Sinaron-SE 1:5.6	658	135	75°	208	64	0	●	●	49 x 0.75	51 / 48	56	66	32	37	-	-	-	-		
	660	150	75°	231	64	0	●	●	49 x 0.75	51 / 51	68	79	45	50	12	16	-	-		
	662	180	75°	276	64	1	●	●	67 x 0.75	70 / 60	91	103	69	76	38	47	-	-		
	664	210	75°	316	64	1	●	●	72 x 0.75	75 / 65	112	124	91	98	60	72	2	3		
	666	240	75°	372	45	3	●	●	86 x 1	90 / 80	140	153	120	128	90	104	36	43		
	668	300	75°	448	64	3	■	■	100 x 1	105 / 80	178	192	159	168	130	146	79	91		
	670	360	68°	468	64	3	■	■	112 x 1.5	117 / 80	188	202	169	178	140	157	90	102		
Sinaron-W 1:4.5	514	65	105°	170	45	0	●	●	58 x 0.75	60 / 51	36	45	10	12	-	-	-	-	2), 3)	
	516	75	105°	195	45	0	●	●	67 x 0.75	70 / 60	49	59	25	29	-	-	-	-	2)	
	518	90	105°	236	45	1	●	●	82 x 0.75	85 / 70	71	81	48	54	16	20	-	-	2)	
	1:6.8	538	90	102°	221	45	0	●	●	67 x 0.75	70 / 60	63	73	40	45	7	9	-	-	
		540	115	104°	291	45	1	●	●	82 x 0.75	85 / 70	99	111	77	85	47	57	-	-	
		544	155	102°	382	45	1	▲	▲	105 x 1	110 / 90	145	158	125	133	95	110	42	50	
		546	200	102°	495	64	3	▲	▲	135 x 1	140 / 115	200	212	178	188	154	171	105	118	
Sinaron-WE 1:4.5	502	45	110°	131	32	0	● 7)	-	67 x 0.75	60 / 60	15	20	-	-	-	-	-	-	at f/16	
	504	55	110°	163	45	0	● 7)	-	67 x 0.75	70 / 60	32	40	5	7	-	-	-	-		
Apo-Sinaron 1:9	618	240	48°	212	90	1	■	■	49 x 0.75	51 / 37.5	58	68	35	39	1	2	-	-		
	620	300	48°	264	90	1	■	■	49 x 0.75	51 / 37.5	85	96	63	70	32	40	-	-		
	622	360	48°	318	90	3	■	■	58 x 0.75	60 / 58	113	125	92	99	61	73	3	4		
	626	480	46°	396	90	3	■	■	67 x 0.75	70 / 60	152	165	132	141	103	118	50	59	8)	
	628	600	46°	496	90	- ⁹⁾	- ⁹⁾	- ⁹⁾	95 x 1	105 / 90	202	216	183	193	155	172	106	119	4)	
Macro-Sinaron-SE 1:5.6	590	180	70°	1:5 ⁵⁾ 302	64	1	●	●	67 x 0.75	70 / 54	104	116	83	90	52	63	-	-		
		60°	1:1 415								161	174	142	150	113	128	61	70		

1) Complete order number for a lens in a Copal between-the-lens shutter: 441.83. + these last 3 digits.

Complete order number for a lens in Auto Aperture Mount (DB=●): 446.85. + these last 3 digits.

Complete order number for a lens in Auto Aperture Mount (DBM=■): 446.86. + these last 3 digits.

Complete order number for a lens in Special Auto Aperture Mount (DBS=▲): 446.81. + these last 3 digits.

Complete order number for a conversion kit for Auto Aperture Mount (DB=●): 446.75. + these last 3 digits.

Complete order number for a conversion kit for Auto Aperture Mount (DBM=■): 446.76. + these last 3 digits.

Complete order number for a conversion kit for Special Auto Aperture Mount (DBS=▲): 446.71. + the last 3 digits.

2) Maximum aperture is f/5.6 when used with Sinar Auto Aperture behind-the-lens Shutter 521.31.

3) In Auto Aperture Mount (DB), this lens can only be focused at ∞ when used with Wide Angle Bellows 2.

4) With manually set aperture.

5) Image circle for reproduction ratios 1:5 and 1:1.

6) Shutter speeds, size 0: 1/500-1 sec; size 1: 1/400-1 sec; size 3: 1/125-1 sec.

7) Identical to Sinaron Digital Lens (See page 4-5). Center Filters can not be used.

8) The largest possible aperture in DB Auto Aperture Mounts is f/11.

9) The aperture is set manually.

Sinaron Digital Lenses

SINARON DIGITAL LENSES IN AUTO APERTURE (DB) MOUNTS ON LENS BOARDS

446.85.119 – 164

Sinaron Digital Lenses with Auto Aperture Mounts (446.85.119–164) were designed for use with digital single-chip CCD backs. Resolving power and selection of focal lengths are tailored specifically to the small size of the CCD array. In order to reduce stray light and to maintain the best possible camera adjustment capabilities, these lenses are mounted inside the camera.



Sinaron Digital Lenses in DB¹

For use with the Sinarcam2, the Aperture Control Sinarcam 1 and also with Sinar Expolux shutters on Sinar view cameras.

Lens Type	Order Nr.	Compar-able Length ³ with 4x5"	Angle of View	Image Circle	Shift Range ³	Aperture Range (in Sinar Auto Aper-ture Mount)	Scale of Reproduction		
			Stopped down 2f-Stops (at 1:∞)				Opti-mum	Recommended Range	Maximum Range
Sinaron Digital 4.5/35 mm DB	446.85.119	120 mm	85°	67 mm	12 mm	4.5 – 32	1:30	from 1:5	1:∞
Sinaron Digital 4.5/45 mm DB	446.85.123	150 mm	82°	80 mm	22 mm	4.5 – 32	1:30	from 1:5	1:∞
Sinaron Digital 4.5/55 mm DB	446.85.125	210 mm	83°	101 mm	33 mm	4.5 – 32	1:30	from 1:5	1:∞
Sinaron Digital 4/80 mm DB	446.85.128	300 mm	58°	92 mm	28 mm	4 – 32	1:10	1:2 – 1:15	1:30
Sinaron Digital 5.6/90 mm DB	446.85.129	300 mm	76°	140 mm	53 mm	5.6 – 45	1:20	from 1:5	1:∞
Sinaron Digital 4/105 mm DB	446.85.130	360 mm	54°	107 mm	36 mm	4 – 32	1:6	1:2 – 1:15	1:30
Sinaron Digital 5.6/135 mm DB	446.85.133	480 mm	58°	150 mm	56 mm	5.6 – 64	1:10	from 1:5	1:∞
Sinaron Digital 4.8/180 mm DB ²	446.85.136	600 mm	50°	168 mm	67 mm	4.8 – 32	1:6	1:2 – 1:10	1:30
Sinaron Digital Macro 5.6/120 mm DB	446.85.131	400 mm	46°	122 mm 204 mm 305 mm	44 mm 85 mm 137 mm	5.6 – 45	1:5 1:1 2:1	1:5 – 2:1	1:5
Sinaron Digital HR 4.0/60 mm DB ⁴	446.85.164	210 mm	60°	70 mm	15 mm	4 – 32	1:30	from 1:10	1:∞

¹ Not suitable for use with external filter wheels (vignetting).

² In order to attain reproduction ratios greater than 1:2 with the 180 mm lens, the Sinar e Digital Camera has to be used with Rail Clamp e 411.51.

³ Valid for all professional digital backs with chip sizes of 24 x 36 mm or 30 x 30 mm. Adjustment ranges with Sinarback22 will be up to 6 mm larger.

⁴ Special lens with very high resolving power.

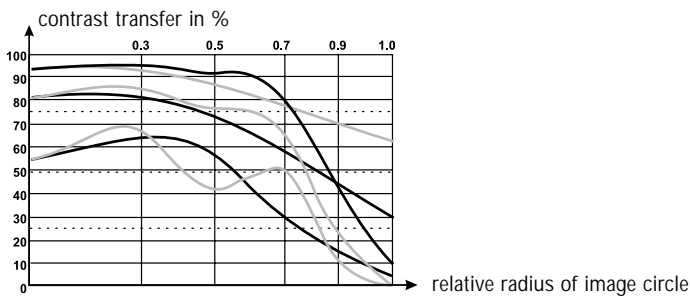

Conventional Lens

The MTF (modulation transfer function) curve shows the contrast transfer (in dependence of the image circle radius) of a 300 mm conventional view camera lens at (top to bottom) 5, 10 and 20 line pairs/mm.

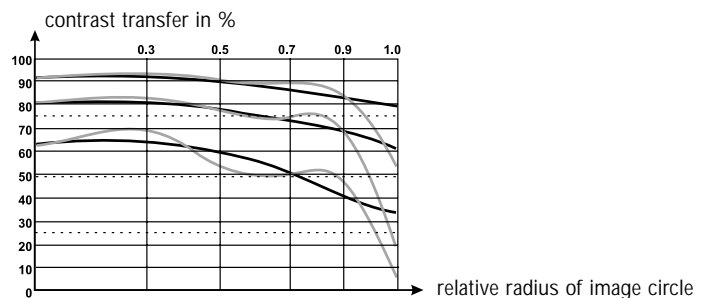

Sinaron Digital Lens

This curve shows the contrast of an 80 mm Sinaron Digital lens (equivalent to 300 mm in 4x5") at 10, 20 and 40 line pairs/mm. Note that the digital lens performs better at 40 lp/mm than the conventional lens does at 20 lp/mm. Thanks to the better contrast and resolution Sinaron Digital lenses are best suited for digital photography.

SINARON DIGITAL LENSES WITH FOCUSING MOUNTS (EF) ON LENS BOARDS

445.83.103 – 113

Fast, contrasty and apochromatically corrected Sinaron Digital lenses optimized for digital imaging in focusing mounts for practical application on the compact versions of all Sinarcams.



Sinaron Digital Lenses in EF*

For use on the compact versions of all Sinarcams

Lens Typ	Order Number	Focusing Range	Image Circle at f/11	Aperture Range	Scale of Reproduction			Filter Ø
					Optimum	Recomm. Range	Max. Range	
Sinaron Digital 4,5/45 mm EF	445.83.103	0.4 m – ∞	125 mm	4.5 – 32	1:30	from 1:5	1:∞	67 mm
Sinaron Digital 5,6/90 mm EF	445.83.109	1.3 m – ∞	140 mm	5.6 – 45	1:30	from 1:5	1:∞	67 mm
Sinaron Digital 5,6/135 mm EF	445.83.113	2.7 m – ∞	150 mm	5.6 – 64	1:30	from 1:5	1:∞	49 mm
Sinaron Digital Zoom 2.8/35-80 mm**	445.81.060	0.6 m – ∞	43 mm	2,8 – 22	–	from 1:15¹ from 1:5²	1:∞¹ 1:∞²	62 mm
* EF = Focusing Mount. ** The respective lens board 556.63.011 has to be ordered separately.					¹ at 35 mm, ² at 80 mm			

LENS ADAPTER BOARDS FOR THE SINARCAM COMPACT

556.63.010 – 556.64.061

When the Sinarcam is used in its compact version, adapter boards permit the use of other lenses in addition to the Sinar Digital Lenses, such as Hasselblad, Mamiya, Nikon, Olympus and Leica.

- Lens boards with automatic spring-loaded aperture control (auto) automatically stop the lens down to the preselected working aperture when the live focusing image is turned off, thus enhancing the ease of operating the Sinarcam Compact even further.

- A special shifting board that permits perspective correction is available for Hasselblad- and Mamiya 645 lenses.



digital man

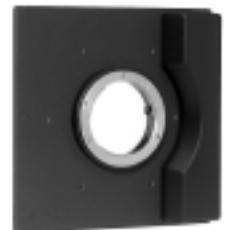

digital auto



shift

Lens Adapter Boards		
For lenses by	Description	Order Number
Sinar	Sinaron Bayonet Board, digital man	556.63.010
	Sinaron Bayonet Board, digital auto	556.63.011
Nikon	Nikon Bayonet Board, digital auto	556.63.021
Leica	Leica R Bayonet Board, digital man	556.64.030
Hasselblad	Hasselblad Shift Board, digital man	556.64.051
Mamiya	Mamiya 645 Shift Board, digital man	556.64.061

GRADUATED FILTERS

(Center Filter)
440.99.214 – 244

Concentrically graduated neutral density filters whose density diminishes from the center towards the transparent edge. Recommended for use when short-focal-length Sinaron-W lenses are used with critical subjects (for instance with large uniformly colored area like a blue sky).



Lens Thread	Center Filter	Filter thread	Application
M58x0.75	440.99.236	M77x0.75	Sinaron-WE 4.5/45 mm (first serie) Sinaron-W 4.5/65 mm Sinaron-W 6.8/75 mm
M67x0.75	440.99.214	M86x1	Sinaron-WE 4.5/45 mm Sinaron-WE 4.5/55 mm Sinaron-W 4.5/75 mm Sinaron-W 6.8/90 mm
M82x0.75	440.99.218	M112x1.5	Sinaron-W 4.5/90 mm Sinaron-W 6.8/115 mm
M105x1	440.99.244	M127x1	Sinaron-W 6.8/155 mm

CODE SINARON DB/DBM

440.91. ... /440.92. ...

LENS CODES FOR LENSES OTHER THAN SINARON LENSES

440.90.999

Code Plates for automatic recognition of Sinaron lenses with Aperture Mounts (DB/DBM) when used with a Sinar Expolux Shutter.

Order numbers for Code Plates for Sinaron lenses (DB/DBM):
440.91./440.92. plus the last three digits of the order number for the lens (see table on page 4-5).

- When ordering Code Plates for lenses other than Sinaron lenses, please provide accurate information about the type and the focal length of the lens.

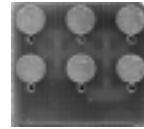

LINHOF LENS BOARD ADAPTER

441.91

For using lenses mounted on Linhof lens boards on a Sinar camera (from Linhof Technika IV and V, Master Technika and Super Technika cameras). Cannot be combined with Sinar behind-the-lens shutters.



LENS BOARD HOLDER

531.41

To prevent the lens board from dropping out when the latch is released accidentally. For attaching to the frame of the lens standard.



Sinar Shutter Systems



Correct exposure is another essential link in the photographic quality chain. In keeping with its standard of highest quality, Sinar offers several metering systems, all of which are based on selective metering at the film plane, thus assuring accurate exposure measurement.

Shutters supplied by Sinar can be classified in two basic types; behind-the-lens and between-the-lens shutters.

● **Behind-the-lens shutters:** Electronic (Sinar Expolux) or mechanical (Sinar Auto Aperture) shutters that are attached behind the lens between the lens standard and the bellows. Behind-the-lens shutters feature the best reproducibility of exposure times for every photograph, independent of the lens being used. These shutters also provide the photographer with outstanding convenience in operating the camera: he or she can control shutter speeds and aperture accurately and quickly without having to move from the position behind the camera.

● **Between-the-lens shutters:** These are mechanical units that are integrated into the lens mount. Most between-the-lens shutters have to be set from the front of the camera, and they have to be closed before the dark slide is removed from a film

holder. They also have to be cocked before each exposure. The fact that each shutter has certain individual tolerances can lead to differences in exposure times when lenses are changed.

Behind-the-lens-shutters are available in the following three variations:

● The **Sinar Expolux Shutter** is a vibration-free, microprocessor-controlled rotating blade shutter that can be operated from the position of the photographer by means of a 3Com-Palm IIIx or V pocket computer. The coded lens is recognized automatically. The aperture (from f/4 to f/128) and the shutter speed (from $1/500$ to 2 seconds and T) can easily be set with a stylus directly on the touch screen of the pocket computer. An automatic cable serves to verify whether there is a film holder in the camera, and the shutter will open or close automatically. Exposure metering at the film plane can also be performed with the Sinar Booster 1 and with a Minolta exposure meter.

● **Sinar Auto Aperture Shutter:** A mechanical behind-the-lens shutter with automatic cocking, exposure time scale visible from both sides ($1/60$ to 8 sec and B), and aperture control (f/4 to f/45). Can be used with lenses in Auto Aperture Mounts (For details see on page 5-4).

All Sinar exposure meters are designed for selective measurement at the film plane, which results in the following practical advantages:

- The photographer performs exposure metering from behind the camera, looking in the direction of the subject. This enables him to concentrate completely on the photograph and its composition.
- It is no longer necessary to calculate exposure compensation to accommodate filter factors or bellows extensions.
- The photographer meters important details of the subject and also takes into account contrast characteristics of the film, or – and this is particularly important – the requirements of the printer.

Sinar offers the following products for perfect exposure metering:

● **Sinar Booster 1:** Is a metering probe for continuous light and for flash that works with Minolta Flashmeters III, IV, V and Autometer IVF. It can be used with all film formats.

● **Bron FCM Metering Probe:** Has the same features as the Sinar Booster 1, but designed to work with Broncolor's flash exposure meter.

Sinar Expolux Shutter

EXPOLUX SHUTTER XT

522.21.008

Its microprocessor-controlled rotary blades ensure an even exposure, also in fast shutter speeds. The shutter is operated by means of a Palm IIIx or V pocket computer from 3Com and the Sinar Palm-Expolux Controller 522.21.038. The range of parameters controlled by the software makes it possible to tailor the shutter specifically to the task at hand. The range of shutter speeds extends from $1/500$ to 2 seconds and T in $1/3$ aperture stops. The range of apertures that can be controlled automatically ranges from f/4 to f/128, depending on the lens in the Auto Aperture Mount.

- The power supply and the communication link with the Palm Computer take place by means of the Expolux RS-232 Power Supply Unit 522.21.046.
- A behind-the-lens filter holder 100mm (4") 547.41 is included.



PALM EXPOLUX CONTROLLER

522.21.038

The Sinar Expolux XT shutter 522.21.008 is controlled and operated by means of the PalmExpolux software, which is loaded on a Palm IIIx or V pocket computer from 3Com.

- Lenses equipped with Expolux coding tablets are recognized automatically, so that the shutter always "knows" exactly which lens is being used.
- Apertures (from f/4 to f/128) and shutter speeds (from $1/500$ to 2 seconds and T) can easily be set directly on the touch screen of the pocket computer by means of a stylus. For better evaluation of the depth of field, the aperture can also be stopped down to the working aperture.
- An automatic cable serves to detect whether there is a film holder in the camera. The shutter closes automatically when a film holder is inserted into the camera and it remains closed until the film holder is removed.
- Exposure metering at the film plane can also be performed with the Sinar Booster 1 and with a Minolta exposure meter
- In order to keep the photographer's hands free for making the settings on the camera, the Pocket computer can be placed in a special holder that comes with the PalmExpolux Controller Kit and that can be attached to the Basic Rail.



sinar Shutters/Exposure Metering

In order to operate the Sinar Expolux Shutter, the following items are required in addition to the PalmExpolux Controller, and they are to be ordered separately:

- 522.21.008 Expolux XT Shutter
- 522.21.046 Expolux RS-232 Power Supply
- 522.21.021 Expolux Control Cable, long
- 522.21.032 Expolux Release/Automatic Cable
- 551.32.034 Expolux Release Cable, long
 - 3Com Palm IIIx or Palm V
 - 3Com Data Cable(see the operating instructions for the PalmExpolux)
 - Windows Computer for the initial installation

The product package includes the following items:

- PalmExpolux Software (diskette)
- PalmExpolux Holder
- Operating instructions

EXPOLUX BOOSTER

525.21

Metering probe with a silicon photo diode for selective exposure measurement at the film plane for electronic flash, continuous illumination or mixed light. The power supply and the interpretation of measured values take place exclusively by means of the Expolux Monitor 522.21.003, which has been discontinued in the meantime.

Can be used with 4x5"/10x12.5 cm to 8x10"/20x25 cm Metering Backs 462.16/.17/.58 or 4x5"/10x12.5 cm Light Meter Cassette 525.16 and 5x7"/13x18 cm Light Meter Cassette 525.17. Length of cable: 1.15 m (46").



EXPOLUX POWER SUPPLY RS 232

522.21.046

Power supply with an RS-232 Interface for operating the Expolux XT Shutter 522.21.008. The long Expolux Control Cable 522.21.021 is required for establishing the connection with the Expolux shutter. Mains voltage range 100–240 V AC, 50–60 Hz, self-adjusting. Mains power cable is included.



Sinar Auto Aperture Shutter

SINAR AUTO APERTURE SHUTTER

521.31

Mechanical behind-the-lens shutter with spring-loaded aperture control. The Sinar Auto Aperture Shutter enables you to concentrate more on the photograph and less on camera operating technique.

- You operate the shutter from behind the camera, where you belong. No longer do you have to kneel before your camera in order to check whether the aperture is stopped down, the shutter closed or even cocked.
- The shutter is always fully open until just before the exposure is made, for maximum brightness of the focusing screen.
- When you insert the film holder into the camera, the shutter automatically closes. That makes the time lost because of accidentally exposed films a thing of the past.
- When the shutter is released, the unique Sinar spring-loaded aperture control (DB) automatically closes the aperture down to the preselected value and the shutter is automatically re-cocked.
- Shutter speed range: $\frac{1}{60}$ to 8 seconds and B.
- Aperture stop settings range from f/4 to f/45 (smaller apertures can be set with lenses in DBM aperture mounts. Also see chapter 4 about this feature).
- A filter holder that can take up to three 100 mm filters is supplied with the shutter.
- In order for lenses to be used with the Sinar Auto Aperture Shutter, they have to be mounted in DB aperture mounts. Photographers can easily update existing lenses with between-the-lens-shutters themselves by using Sinar DB Conversion Kits.
- The Sinar Auto Aperture Shutter is supplied with an appropriate filter holder, release cable 521.61, automatic cable 521.51, bayonet piece 521.91 and synchro cable adapter with standard plug 522.11.005.



Sinaron lenses with Copal between-the-lens shutters equipped with a tube on the lens plane can also be used with a Sinar Auto Aperture behind-the-lens shutter. However, the aperture has to be set manually on the shutter (see Order No.441.83. ... on page 4-4).

Y-SYNCHRO CABLE

521.51.010

Connects the exposure meter with the shutter and with the electronic flash unit. Permits flash synchronization during exposure metering and during exposure without having to change connections. Length: 1 m (40").



COUPLING PIECE FOR 521.51

521.81

Two Automatic Cables 521.51 can be joined with this Coupling Piece for use with long camera bellows extensions.



SYNCHRO LEAD ADAPTER

522.11.005

For connecting conventional flash synchronization cables or remote releases to Sinar Auto Aperture Shutter 521.31 or to Sinar Digital Shutter 522.11.



Exposure Metering

a brief introduction

1. Know the process!

Have you ever wondered why your transparencies look great on a lightbox, but you are disappointed when you see them reproduced in print?

- A simple reason is the contrast range. A transparency can reproduce details from the brightest highlights to the darkest shadows, a range of more than six aperture stops.
- As soon as the very same picture is reproduced with printing inks on paper, this range is reduced to only four aperture stops.
- Somewhere between the original exposure and the printed image there is a lithographer who decides what part of this visual information must be sacrificed. This is really so – there is somebody else who passes judgment on your work!

We would like to describe a few simple steps that will help you to understand the production process so that you can anticipate what your pictures will look like in print.

2. Exposure Metering

To control the reproduction process means to measure the contrast range of your pictures.

- In order to reproduce a subject as accurately as possible, all the important information, from shadow detail to the brightest highlight with detail, should be contained within a contrast range of four measured aperture stops.
- For the most accurate exposure measurements with large format cameras, an exposure meter should be used that measures the light at the film plane.

The most important elements in exposure measurement are the following:

- The midtone (e.g. with the Kodak Q-18 Neutral Gray Card).
- The darkest area in which you want to hold detail.
- The brightest area in which you want to hold detail.

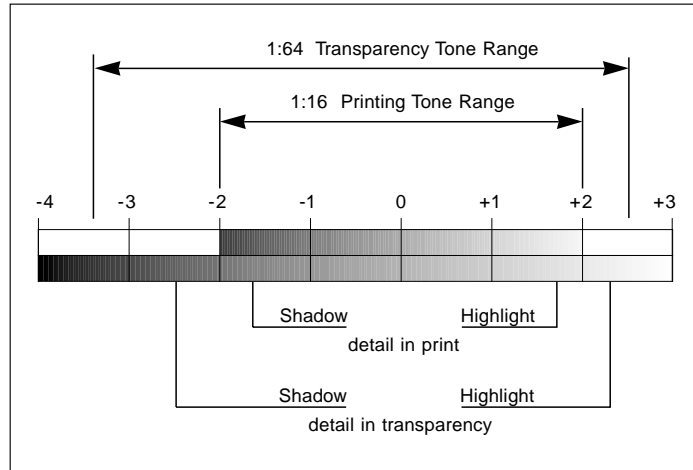

Examine the contrast range of your transparencies. Now look at the “window”: all this visual information has to be compressed, so that it can be reproduced in a printed reproduction. If you do not have control over this process, you will never be able to tell exactly how your work will look when it is finally reproduced in print.

Remember that the contrast range between these two areas must not exceed four aperture stops!

The most precise method of exposure measurement is through the lens exposure metering using a metering probe at the film plane. That means that any point can be measured and that the contrast range can be controlled.

The practical advantages of exposure measurement at the film plane are the following:

- The photographer performs the metering behind the camera, while he or she has the subject in view, so that he or she can devote full attention to the camera and to picture composition.

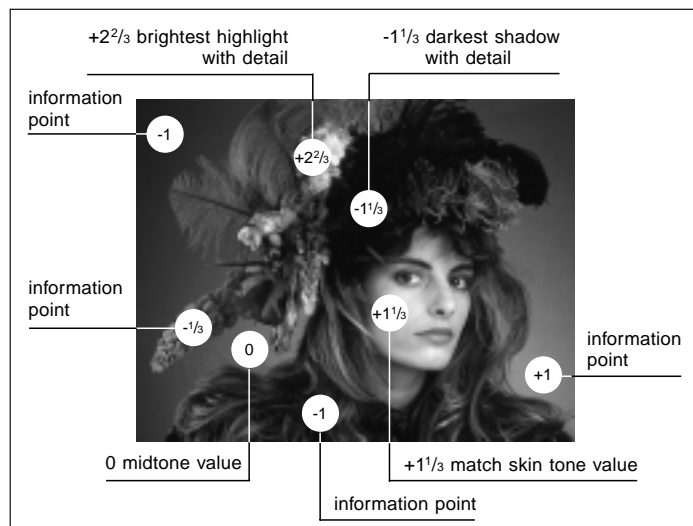

- Extension factors for the exposure time that normally arise from the use of filters, bellows extensions, etc. are taken into account automatically.
- Important parts of the image can be measured precisely.
- The photographer determines the tonal values, unaffected by the often varying sizes of the image areas with different brightness values.
- Staying within acceptable tolerances of tonal values in the contrast ranges is a basic prerequisite for good picture reproduction;

3. Communication

Without good communication between you the photographer and the lithographer, the latter has no reference points for the

interpretation of your pictures:

- Which details must be preserved and which can be left out?
- What areas must be considered with special care for color rendition?
- Where is the midtone value?

Simply by identifying the measured points on a Polaroid print or on a transparency, this information can easily be passed along to the lithographer. Some of the pertinent information that can be communicated in this manner is the following:

- Midtone value, darkest shadow area with detail and brightest highlight with detail;
- Areas that can be saturated black or totally white (i.e. which do not have to have detail rendition).
- Areas that require special attention for color rendition (such as skin tones or important saturated color areas).
- Determination of the effective light value of specific points, for reference. Single out a point, for instance, that has 1 stop above the midtone value (+1), or that is a 1/3 stop below that value (-1/3).

Communication has to be nurtured by all those who are involved in the reproduction process: the photographer, the client, the lithographer and the printer.

Accessories

SINAR BOOSTER 1

525.11

Equipped with a silicon photo diode, the Sinar Booster 1 light metering probe is designed for use with Minolta Flashmeter III, IV and V, as well as the Autometer IV F exposure metering devices. Selective exposure metering at the film plane is universally possible with flash-, continuous- and mixed lighting. Thanks to its long metering probe, the Sinar Booster 1 can be used with metering backs 4x5"/10x12.5 cm 462.16, 5x7"/13x18 cm 462.17, and 8x10"/20x25 cm 462.58 or with Light Meter Cassettes 4x5"/10x12.5 cm 525.16 and 5x7"/13x18 cm 525.17.



SINAR PROBE FCM

525.12

Same features as Sinar Booster 1, but compatible with the technology of Broncolor's exposure meter FCM.



The metering backs in which these exposure metering probes can be used are listed in Section 3, "System Components", page 3-5.

LIGHT METER CASSETTE 4x5"/10x12.5 cm

525.16

Accepts the metering probes of all exposure meters equipped with such probes. Fits all professional cameras with internationally standardized 4x5"/10x12.5 cm backs.

LIGHT METER CASSETTE 5x7"/13x18 cm

525.17

Accepts the metering probes of all exposure meters equipped with such probes. Fits all professional cameras with internationally standardized 5x7"/13x18 cm backs.



HOLDER PLATE FOR MINOLTA FLASHMETERS

525.16.005

Holder Plate for attaching Minolta Flashmeters III, IV or V (when Sinar Booster 1 is being used) on Light Meter Cassettes 4x5"/10x12.5 cm 525.16 and 5x7"/13x18 cm 525.17.



HOLDER PLATE FOR LIGHTMETER

462.96.006

Holder Plate for attaching exposure meters such as Minolta Flashmeters III, IV, V or Autometer IV F (when Sinar Booster 1 is being used) to a carrier frame, to a metering back, or to a holder frame.



Precision that pays for itself



Every Sinar camera accepts basically all film holders that conform to international standards and that are used on so-called international camera backs. Because they accommodate two sheet films, double sheet film holders are the most frequently used holders for the 9 x 12 cm, 4 x 5"/10 x 12.5 cm, 5 x 7"/13 x 18 cm, 18 x 24 cm and 8 x 10"/20 x 25 cm formats.

The Sinar Precision Sheet Film Holder

For the most exacting demands and for photographs with meticulously defined planes of sharpness, Sinar designed its own metal film holder with a full-size pressure plate and a patented film tensioning system that ensures the best possible film flatness. This also eliminates any movements of the film during the exposure. The advantages of this film holder are particularly valuable for photographs with multiple exposures or selective sharpness. The Sinar Sheet Film Holder is designed for single sheets of film, which greatly simplifies film loading. It also permits the imprinting of a photographer's copyright on the border of a photograph by means of a strip of litho film that can be inserted in special slots along the edge of a film holder's frame. Photographs can also be numbered from 0 to 9 by means of a built-in numbering dial.

The Sinar Adhesive Sheet Film Holder

Sinar offers an improved version of the conventional sheet film holder for the 5 x 7"/13 x 18 cm and 8 x 10"/20 x 25 cm formats. The sheet film is not inserted into the holder: it is laid down against a reference edge on a permanently self-adhesive surface. This eliminates uneven film surfaces, to which the larger sheet film formats are especially susceptible.

In addition to sheet film holders and rollfilm holders, virtually every large format camera outfit should also include an instant film holder. To that end, Sinar offers Polaroid Sheet Film Holder Model 545 for 4 x 5"/10 x 12.5 cm. Instant pictures are very useful in professional photography for checking exposures and lighting or for particularly urgent assignments.

The Sinar Zoom Rollfilm Holder

Large format cameras are not at all restricted to the use of sheet films. Sinar has developed a rollfilm holder with an extremely precise film channel and a pressure plate for optimum film flatness. It distinguishes itself because it is so easy and so safe to handle. An outstanding advantage of the Sinar Zoom Rollfilm Holder is the quick selection of image formats of 4.5x6, 6x6, 6x7, 6x9 and 6x12 cm. To change the format, masks are shifted internally and the film advance is adjusted accordingly. Therefore, no film is wasted when the format is changed, and it can be changed at any time.

The use of the Sinar Zoom Rollfilm Holder has one other interesting benefit: by changing the picture format, which can be done at any time, it is also possible to change the

usable angle of view of the lens that is being used. This reduces the number of lenses that need to be taken along, and the photographer is able to adapt the format to the most desirable cropping of his subject without having to change his camera position. Films in the rollfilm holder can be replaced very quickly, because pre-loaded rollfilm cartridge inserts can be taken along, making that task quite easy. Sinar guarantees the best sharpness performance with Sinar Sheet Film Holders and Sinar Zoom Rollfilm Holders.

The Sinar Zoom Rollfilm Holder: Angle of View for different Formats						
Lens, Focal Length	Resulting Angle of View in Degrees by Format:					
	4.5x6	6x6	6x7	6x9	6x12	4x5"
75 mm	49°	55°	62°	70°	80°	92°
90 mm	43°	48°	54°	60°	70°	82°
150 mm	26°	29°	33°	38°	46°	54°
180 mm	22°	24°	28°	32°	40°	48°
240 mm	16°	18°	21°	25°	30°	36°
300 mm	13°	15°	17°	19°	23°	27°
360 mm	11°	12°	14°	16°	20°	24°
480 mm	8°	9°	11°	13°	15°	18°
600 mm	6°	8°	9°	10°	12°	14°

sinar Film Holders

SINAR SHEET FILM HOLDER 4x5"/10x12.5 cm

566.36

Precision single sheet film holder with a new loading system for one sheet of 4x5"/10x12.5 cm film.

A two-stage pressure plate holds the film firmly in place so that it cannot shift within the holder.

An external signal indicates whether the holder is loaded and whether the film has already been exposed. A safety button permits the dark slide to be removed from a loaded holder only when that holder has been inserted in the camera. This prevents unintentional exposures.

● There is a provision for imprinting a copyright notice and a two-digit number on the edge of the film.



LOADING TRAY FOR 566.36

566.36.001

Loading guide for even easier insertion of sheet film into Sinar precision Sheet Film Holder 566.36.

Quality over All

A quality chain is only as strong as its weakest link. Sinar has set itself the task of steadily eliminating the weakest elements of that chain. That was the reason for Sinar to develop its own precision sheet film holder, which keeps the film in a remarkably flatter position than familiar double sheet film holders do. Maximum deviation of the film plane from the ideal image plane amounts to an exceedingly small ± 0.03 mm ($1/800''$). In conventional sheet film holders, this deviation can amount to 0.3 mm ($1/80''$) and more, regardless of the film type being used.

The comparison photographs on the right (magnified 20x) show a test photograph with the film surface in the optimum plane and another with the film surface displaced 0.3 mm ($1/80''$) from the optimum image plane (both at full aperture).



Cross-section of a Sinar precision Sheet Film Holder.

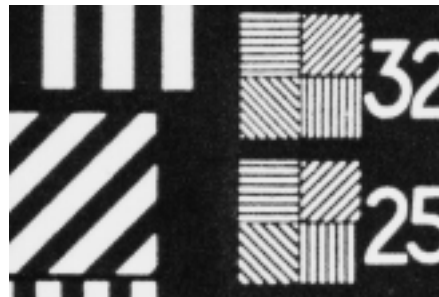

Test photograph with the film plane in the optimum position.

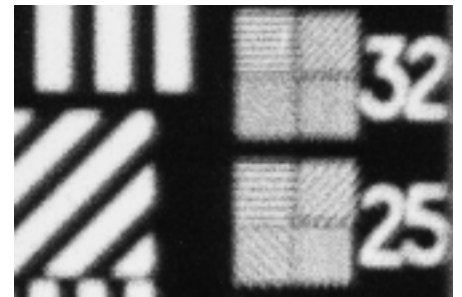

Film displaced only 0.3mm ($1/80''$) from the optimum image plane (at full aperture).

SINAR ADHESIVE SHEET FILM HOLDER 13x18 cm

566.37

Sheet film is kept very flat by means of an adhesive layer, which also keeps it from shifting or curling out when the camera is tilted downwards. That makes unexpected areas of unsharpness a thing of the past. Excellent film flatness makes this holder an important tool, especially for photographs with multiple exposures. The holder can be reloaded several hundred times. Replacement adhesive sheets are available.



SINAR ADHESIVE SHEET FILM HOLDER 8x10"/20x25 cm

566.38

Sheet film holder for single sheets of 8x10"/20x25 cm film. Its features are the same as those of 566.37, above.

sinar Film Holders

DOUBLE SHEET FILM HOLDER 4x5"/10x12.5 cm

566.56

DOUBLE SHEET FILM HOLDER 9x12 cm

566.46

DOUBLE SHEET FILM HOLDER 13x18 cm

566.47

DOUBLE SHEET FILM HOLDER 8x10"/20x25 cm

566.58

These sheet film holders are made of tough unbreakable molded material and they accommodate two sheets of film. They fit on all cameras with internationally standardized backs.

- The grips on the dark slides are white on one side and black on the other. By inserting the dark slide reversed after a photograph has been exposed, this makes it easy to tell which holders still have an unexposed film available.



SINAR ROLLFILM HOLDER ZOOM 2

567.32

The Sinar Zoom 2 Rollfilm Holder is inserted into the camera just like a standard film holder. It is designed for 120- or 220-size rollfilm and it fits all 4x5"/10x12.5 cm cameras with an internationally standardized back. The number of exposures depends on the format that has been selected, which can be changed from 4.5x6 cm to 6x12 cm at any time – without overlapping images. The design of the holder assures an absolutely flat film plane. Supplied with Vario Mask 534.12 and Universal Mask 534.22.

- You need only this single rollfilm holder and a view camera to cover all current rollfilm picture formats.
- There may be some limitations to the use of these rollfilm holders with certain cameras other than Sinar cameras (Graflock grooves). Our representatives will be pleased to advise you.



VARIO MASK

534.12

For masking the format in a Sinar Zoom Rollfilm Holder. Adjustable from 4.5x6 cm to 6x12 cm.

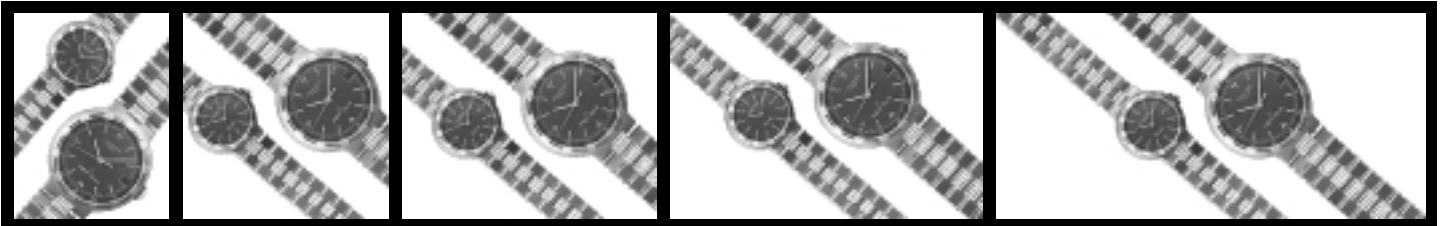

4,5x6 cm

6x6 cm

6x7 cm

6x9 cm

6x12 cm

One for All

For certain assignments it makes good sense to use rollfilm. If the advantages of a large format camera are still wanted, then a rollfilm holder is the ideal solution. As a result of the special design of the Sinar Rollfilm Holder, it is no longer ne-

cessary to remove the back of the camera before an exposure is made. Film flatness is also markedly better than it is in conventional rollfilm holders. The picture format can be changed at any time, even in the middle of the film. This permits the best

utilization of the film. Other advantages of rollfilm are the wide variety of film types available in that form and its space-saving configuration, which is especially convenient for travelling.

sinar Film Holders

SINAR ROLLFILM HOLDER 6x9 cm

567.45

SINAR ROLLFILM HOLDER 6x7 cm

567.54

Sinar 6x9 cm and 6x7 cm Rollfilm Holders are inserted into the camera just like normal sheet film holders and they fit all 4x5"/10x12.5 cm cameras with internationally standardized backs. They are designed for 120- and 220-size rollfilms, for 8 and 16 or 10 and 20 exposures, respectively. The design of these rollfilm holders assures excellent film flatness. Supplied with Mask 534.25 for the 6x9 cm format, or Mask 534.29 for the 6x7 cm format, respectively.



FILM CARTRIDGE

567.92

For use in Sinar rollfilm holders. Individual cartridge for preloading. Permits quick film change in rollfilm holders.



POLAROID SHEET FILM HOLDER P 545 i

765.96

Film Holder for 4x5"/10x12.5 cm instant sheet films.



HASSELBLAD FILM MAGAZINE ADAPTER

556.64.010

Permits the adaptation of the film magazine of a Hasselblad camera to a Sinar camera. This adapter, which is equipped with a coupling device for the film magazine, can be mounted on the Sinar carrier frame in place of the focusing screen frame. The corresponding format mask, which is to be mounted on the focusing screen together with a fresnel lens carrier, is included with the adapter.



MAMIYA FILM MAGAZINE ADAPTER

556.64.020

Permits the adaptation of the film magazine (6x7, 6x8, also powered) of a Mamiya RB camera to a Sinar camera. For additional information see Hasselblad Film Magazine Adapter.



Using Filters – the right way!



Filters are an exceedingly important topic in creative and very precisely executed photography, primarily when our subjective perception of something is to be changed, or when a particular effect needs to be created.

Whereas our eyes always perceive colors as “correct”, even under the most diverse kinds of illumination, film often reacts quite differently. Film is balanced for a specific color temperature, and when it is used with a light source that has a different color balance, the results will show a greater or smaller color cast. Filters provide us with the opportunity of softening, eliminating or intensifying that color cast. Filters can also be used to achieve certain pictorial effects or to influence the overall mood of an image.

Sinar offers a complete selection of Color Control Filters that were developed in accordance with precise sensitometric principles and produced in fine density steps with tight tolerances. Filters too, are subjected to rigid quality control at Sinar. It is a firm belief at Sinar that filters have to be as precise optically as the lens itself. Otherwise what good is a superb lens when its high performance is impaired by a low-quality filter?

● **Neutral Density (ND) Filters:** Gray filters that serve to reduce light intensity without changing other light characteristics. They are used when slower shutter speeds or greater apertures are wanted. Available in densities of 0.1, 0.2, 0.3, 0.6 and 0.9. A neutral gray density of 0.3 reduces the light intensity by one stop.

● **Color Compensating (CC) Filters:** These filters are used for correcting a color cast that is inherent either to the film or to its processing, or for changing the color

rendition of a photograph. They are available in the colors yellow (Y), magenta (M), cyan (C), blue (B), green (G) and red (R), and in color densities of 0.025, 0.05, 0.1, 0.15, 0.2, 0.3, 0.4 and 0.5.

● **Conversion Filters:** For changing the color quality of a light source to match the quality of the light for which a color film is balanced, or for rendering a scene in warmer (redder) colors or colder (bluer) colors. Blue filters bear the numbers 80 and 82, orange filters are numbered 81 and 85. Depending on their conversion strength, they are identified with an additional letter (A = weak through D and EF = strong).

● **Contrast Filters:** Are used in black-and-white photography for altering the rendition of tonal values. Colors can be reproduced in equivalent tonal values or in tonal values that differentiate better when there are several colors with similar tonal values in a scene. The basic rule is that the color of the filter is reproduced lighter and its complementary color is reproduced darker.

● **Graduated Filters:** Are used for altering the color or the density of a portion of the photograph. Graduated neutral density filters are available in three different density gradients: 0–0.3, 0–0.6 and 0–0.9. Graduated color filters are available with gradient densities of 0–0.6 in the colors yellow, blue, chocolate, sepia, tobacco, violet, coral pink, copper/yellow (sunset), blue/pink (twilight) and pink. Graduated neutral density filters also serve to reduce excessive contrast in a photograph.

● **Filters for Special Effects:** Used primarily in advertising and in portrait photography for achieving a particular pictorial effect. The most commonly used

special effect filters are soft-focus filters of various strengths whose flare characteristics produce a measured amount of pleasing unsharpness. Another type is the star filter, which imparts a four-, six- or eight-point star to every highlight in the picture.

● **Polarizing Screens:** Used for softening or eliminating reflections on non-metallic surfaces under certain conditions. Another application is a darker reproduction of a blue sky in a color photograph.

Sinar filters are made of high grade CR-39 plastic material, the same material that is used for eyeglasses and for other optical elements. Sinar Color Control Filters are supplied in two sizes: 100 x 100 mm (4 x 4”), 1 mm thick and 125 x 125 mm (5 x 5”), 3 mm thick. Their designations correspond to those of Kodak Wratten filters. With the extensive Sinar Adapter System, they can be used on virtually any large or medium format camera.

100 x 100 mm (4 x 4”) filters can be used in front of the lens and also behind the lens. It is more advantageous to place them behind the lens, because this significantly reduces the loss of contrast that is caused by stray light. That is why Sinar offers special Filter Holder 547.41, which is designed to support up to three filters behind the lens. When a combination of several filters is used – especially behind the lens – focusing should be performed with the filters in place.

It is strongly recommended to use probes for film plane metering to accurately measure the light when filters are used.

sinar Color Control Filters

FILTER HOLDER 1/125 mm (5")

547.11

Filter Holder 1 supports a single 125 mm (5") filter. Several filter holders can be stacked and rotated in relation to each other. The back of the holder is designed as an attachment frame that will fit in every Sinar 4x5"/10x12.5 cm standard. Multipurpose Bellows 4x5"/10x12.5 cm 454.11 can be attached directly to Filter Holder 1/125 mm to serve as a lens hood. Adapter rings can also be attached to Filter Holder 1/125 mm. This makes the Sinar 125 mm Filter System excellent for use on any view camera, regardless of brand.



FILTER HOLDER 2/125 mm (5")

547.21

Filter Holder 2/125 mm (5") supports two 125 mm (5") filters or one Linear Polarizing Filter 547.91.750. Its other features are the same as those of Filter Holder 1/125 mm (5") above.



FILTER HOLDER 100 mm (4") FOR BTL SHUTTER

547.41

Filter Holder for use with Sinar Expolux or Sinar Auto Aperture behind-the-lens shutter. Easy to attach to the shutter without tools. Positions filters between the film plane and the lens, so that they are protected from stray light and reflections. Supports up to three 100 mm (4") filters.



FILTER HOLDER 100 mm (4") WITH TUBE

547.51

This Filter Holder 100 mm (4") supports up to three 100 mm (4") filters at a time. One or more lens hood tubes can be attached to its front. Supplied with three 25 mm (1") tubes.

- By means of adapter rings, this Filter Holder can be attached to nearly all lenses on 35 mm and medium format cameras and to many lenses on professional cameras as well (see Adapter Rings 547.81. ...).



ADAPTER RINGS 100 mm (4") and 125 mm (5")

547.81. ...

These Adapter Rings permit the attachment of Sinar Filter Holder 100 mm (4") 547.51 and Sinar Filter Holder 125 mm (5") 547.11 or 547.21 to practically all lenses with filter threads and filter bayonets, respectively. For sizes and order numbers, please see the table on page 7-6 entitled "Adapter Rings".



CAP FOR ADAPTER RING

547.81.002

Protective cap that can be placed on a lens with an adapter ring (for the 100 mm filter system) in place. Diameter: 96 mm (3³/₄").



sinar Color Control Filters

FILTER BOX 100x100 mm (4x4")

547.62.001

Made of wood, for the storage of 10 Sinar Color Control Filters 100 mm (4"). Filters are not included.

● Graduated filters require 100x125 mm (4x5") Filter Box 547.62.002.



547.62.001

547.62.002

FILTER BOX 100x125 mm (4x5")

547.62.002

Made of wood, for the storage of 10 Sinar Color Control Filters and Graduated Filters 100 mm (4").

Filters are not included.

FILTER CASE 125 mm (5")

547.71

The following accessories can be stored in this Filter Case:

- 1 Filter Holder 1/125 mm (5") 547.11 coupled to
- 1 Filter Holder 2/125 mm, plus
- 30 Filters 125 mm (5"), plus
- 6 Adapter Rings, plus
- 4 Graduated Filters, plus
- 1 Cleaning Set.



WALLET FOR FILTERS 100 mm (4")

547.72

The following filters can be stored in this wallet:

- 4 Graduated Filters 100x125 mm (4x5")
- 18 Filters 100 mm (4").



FILTER CLEANING SET

547.79

Sinar Color Control Filters should only be cleaned with this special solution. Other solutions may cause their surfaces to become dull.

Consists of:

- 1 bottle of cleaning fluid
- 1 cleaning cloth.



SWIVELING LINEAR POLARIZING FILTER

546.31

Rotating and swiveling linear polarizing filter with a diameter of 110 mm (4 1/2"). Can be mounted on one of the Rods of 11 cm (4 1/2"), 16 cm (6 1/4") and 25 cm (10") length (see page 3-14).

● Does not require any further filter holders.



GRADUATED FILTERS (Center Filter)

440.99.214 - 244

Concentrically graduated neutral density filters whose density diminishes from the center towards the transparent edge. Recommended for use with short-focal-length Sinaron-W lenses. For more information see page 4-8.



sinar Color Control Filters

CC FILTERS 125 mm (5")

547.91.103–650

Color Compensating Filters for Sinar Color Control Filter System 125 mm (5"). Available in the colors cyan, magenta, yellow, red, green and blue in the densities 0.025, 0.05, 0.10, 0.15, 0.20, 0.40 and 0.50.

For order numbers see table on the right.

CC FILTERS 100 mm (4")

547.92.103–650

Color Compensating Filters for Sinar Color Control Filter System 100 mm (4"). Other features are the same as those of CC Filters 125 mm (5").



Filter 125



Filter 100

ND FILTERS 125 mm (5")

547.91.010–090

Neutral gray filters for the Sinar Color Control Filter System 125 mm (5"). Available in the densities 0.1, 0.2, 0.3, 0.6 and 0.9.

For order numbers see table on page 7-5.

ND FILTERS 100 mm (4")

547.92.010–090

Neutral gray filters for the Sinar Color Control Filter System 100 mm (4"). Other characteristics are the same as those of ND Filters 125 mm (5") above.

CTC FILTERS 125 mm (5")

547.91.801–853

Blue and orange conversion filters for the Sinar Color Control Filter System 125 mm (5").

For available types and Order Numbers, please see the table on page 7-5.

CTC FILTERS 100 mm (4")

547.92.801–853

Blue and orange conversion filters for the Sinar Color Control Filter System 100 mm (4").

Other characteristics are the same as those of CTC Filters 125 mm (5").

Color Correction Filters

Abbreviated Designation	Density/Color	Order Number (100mm/4")	Order Number (125mm/5")	Exposure Compensation in f-stops (approx.)
CC025C	0.025 Cyan	547.92.103	547.91.103	0
CC05C	0.05 Cyan	547.92.105	547.91.105	+ 1/3
CC10C	0.10 Cyan	547.92.110	547.91.110	+ 1/3
CC15C	0.15 Cyan	547.92.115	547.91.115	+ 1/3
CC20C	0.20 Cyan	547.92.120	547.91.120	+ 1/3
CC30C	0.30 Cyan	547.92.130	547.91.130	+ 2/3
CC40C	0.40 Cyan	547.92.140	547.91.140	+ 2/3
CC50C	0.50 Cyan	547.92.150	547.91.150	+ 1
CC025M	0.025 Magenta	547.92.203	547.91.203	0
CC05M	0.05 Magenta	547.92.205*	547.91.205	+ 1/3
CC10M	0.10 Magenta	547.92.210*	547.91.210	+ 1/3
CC15M	0.15 Magenta	547.92.215	547.91.215	+ 1/3
CC20M	0.20 Magenta	547.92.220*	547.91.220	+ 1/3
CC30M	0.30 Magenta	547.92.230*	547.91.230	+ 2/3
CC40M	0.40 Magenta	547.92.240*	547.91.240	+ 2/3
CC50M	0.50 Magenta	547.92.250	547.91.250	+ 2/3
CC025Y	0.025 Yellow	547.92.303	547.91.303	0
CC05Y	0.05 Yellow	547.92.305	547.91.305	0
CC10Y	0.10 Yellow	547.92.310	547.91.310	+ 1/3
CC15Y	0.15 Yellow	547.92.315	547.91.315	+ 1/3
CC20Y	0.20 Yellow	547.92.320	547.91.320	+ 1/3
CC30Y	0.30 Yellow	547.92.330	547.91.330	+ 1/3
CC40Y	0.40 Yellow	547.92.340	547.91.340	+ 1/3
CC50Y	0.50 Yellow	547.92.350	547.91.350	+ 2/3
CC025R	0.025 Red	547.92.403	547.91.403	0
CC05R	0.05 Red	547.92.405	547.91.405	+ 1/3
CC10R	0.10 Red	547.92.410	547.91.410	+ 1/3
CC15R	0.15 Red	547.92.415	547.91.415	+ 1/3
CC20R	0.20 Red	547.92.420	547.91.420	+ 1/3
CC30R	0.30 Red	547.92.430	547.91.430	+ 2/3
CC40R	0.40 Red	547.92.440	547.91.440	+ 2/3
CC50R	0.50 Red	547.92.450	547.91.450	+ 1
CC025G	0.025 Green	547.92.503	547.91.503	0
CC05G	0.05 Green	547.92.505*	547.91.505	+ 1/3
CC10G	0.10 Green	547.92.510*	547.91.510	+ 1/3
CC15G	0.15 Green	547.92.515	547.91.515	+ 1/3
CC20G	0.20 Green	547.92.520*	547.91.520	+ 1/3
CC30G	0.30 Green	547.92.530*	547.91.530	+ 2/3
CC40G	0.40 Green	547.92.540*	547.91.540	+ 2/3
CC50G	0.50 Green	547.92.550	547.91.550	+ 1
CC025B	0.025 Blue	547.92.603	547.91.603	0
CC05B	0.05 Blue	547.92.605	547.91.605	+ 1/3
CC10B	0.10 Blue	547.92.610	547.91.610	+ 1/3
CC15B	0.15 Blue	547.92.615	547.91.615	+ 1/3
CC20B	0.20 Blue	547.92.620	547.91.620	+ 2/3
CC30B	0.30 Blue	547.92.630	547.91.630	+ 2/3
CC40B	0.40 Blue	547.92.640	547.91.640	+ 1
CC50B	0.50 Blue	547.92.650	547.91.650	+ 1 1/3

* = Color Meter Filter Kit

Example: CC Filters for Fluorescent Illumination

Type of Fluorescent Lamp	Daylight Color Film	Tungsten Color Film
Daylight	40Y + 40M	30Y + 40M + 85B (CTC)
White	30M + 20C	50Y + 60M
Warm White	40M + 40C	40Y + 50M
Warm White Deluxe	30M + 60C	10Y + 10M
Cool White	30M	50R + 10R
Cool White Deluxe	10M + 20C	40Y + 20M

sinar Color Control Filters

Neutral Density Filters

Abbreviated Designation	Density/Color	Order Number (100 mm/4")	Order Number (125 mm/5")	Exposure Compensation in f-stops (approx.)
1ND	0.1 neutral	547.92.010	547.91.010	+1/3
2ND	0.2 neutral	547.92.020	547.91.020	+2/3
3ND	0.3 neutral	547.92.030	547.91.030	+1
6ND	0.6 neutral	547.92.060	547.91.060	+2
9ND	0.9 neutral	547.92.090	547.91.090	+3

SE FILTERS 125 mm (5")

547.91.750 – 758

Special effects filters for the Sinar Color Control Filter System 125 mm (5"). See the "Special Effects Filters" table on page 7-6 for types and order numbers.

SE FILTERS 100 mm (4")

547.91.750 – 758

Special effects filters for the Sinar Color Control Filter System 100 mm (4"). See the "Special Effects Filters" table on page 7-6 for types and order numbers.

Color Temperature Correction Filters

Abbreviated Designation	Color	Order Number (100 mm/4")	Order Number (125 mm/5")	Correction in MIRED**, Exposure Compensation in f-stops (approx.)	
80A	80A Blue	547.92.801	547.91.801	-131	+2
80B	80B Blue	547.92.802*	547.91.802	-112	+1 2/3
80C	80C Blue	547.92.803*	547.91.803	-81	+1
80D	80D Blue	547.92.804*	547.91.804	-56	+1/3
82	82 Blue	547.92.820*	547.91.820	-10	+1/3
82A	82A Blue	547.92.821*	547.91.821	-21	+1/3
82B	82B Blue	547.92.822*	547.91.822	-32	+2/3
82C	82C Blue	547.92.823*	547.91.823	-45	+2/3
81	81 Orange	547.92.810*	547.91.810	+9	+1/3
81A	81A Orange	547.92.811*	547.91.811	+18	+1/3
81B	81B Orange	547.92.812*	547.91.812	+27	+1/3
81C	81C Orange	547.92.813*	547.91.813	+35	+1/3
81D	81D Orange	547.92.814*	547.91.814	+42	+2/3
81EF	81EF Orange	547.92.815*	547.91.815	+52	+2/3
85	85 Orange	547.92.850*	547.91.850	+112	+2/3
85B	85B Orange	547.92.852	547.91.852	+131	+2/3
85C	85C Orange	547.92.853*	547.91.853	+81	+1/3

* = Color Meter Filter Kit
 ** = See page 7-7 for the table for the determination of the correct conversion filter.

COLOR METER FILTER KIT 100 mm (4")

598.92

Color Meter Filter Kit 100 mm (4") includes 10 Color Compensating Filters, 15 Conversion Filters and the Filter Cleaning Set. The 25 filters are stored in two protective filter files. Please see the "Color Meter Filter Kit" table for a full list of contents.

BW FILTERS 125 mm (5")

547.91.703 – 735

Black-and-white contrast filters for the Sinar Color Control Filter System 125 mm (5"). For colors and order numbers see table "B/W Contrast Filters".

BW FILTERS 100 mm (4")

547.92.703 – 735

Black-and-white contrast filters for the Sinar Color Control Filter System 100 mm (4"). For colors and order numbers see table below.

Color Meter Filter Kit

Components:	100 mm, Order Number 598.92
Container	Filter Wallet 547.72 (2x)
Filter Cleaning Set	Filter Cleaning Set 547.79
10 Color Correction Filters	2 Colors (Magenta, Green) in 5 Densities (0.05, 0.1, 0.2, 0.3, 0.4)
15 Conversion Filters	Blue (80B, 80C, 80D, 82, 82A, 82B, 82C) Orange (81, 81A, 81B, 81C, 81D, 81EF, 85, 85C)

Black-and-White Contrast Filters

Designation	Color	Order No (100 mm/4")	Order No (125 mm/5")	Applications
8Y	8 Yellow	547.92.703	547.91.703	Sky, clouds, vegetation green
25R	25 Red	547.92.704	547.91.704	Reduces haze, absorbs blue in infrared photography (color separation filter)
58G	58 Green	547.92.705	547.91.705	Darkens magenta and red (color separation filter)
47B	47B Dark Blue	547.92.706	547.91.706	Lightens blue (color separation filter)
1A	1A Skylight	547.92.710	547.91.710	Avoids blue shadows, absorbs ultraviolet
2B	2B Ultraviolet	547.92.715	547.91.715	Absorbs ultraviolet under 390 nm
16O	16 Orange	547.92.720	547.91.720	Contrast filter, darker rendition of the sky
38LB	38 Light Blue	547.92.725	547.91.725	Improved rendition of yellow and orange
11YG	11 Yellow-Green	547.92.730	547.91.730	Better tonal values in artificial light (portrait, vegetation)

sinar Color Control Filters

Special Effect Filters

Designation	Density	Order No (100 mm/4")	Order No (125 mm/5")	Applications
LP	0.4	546.31.000*	547.91.750**	Rotating and swiveling linear polarization filter, eliminates reflections; + 1/3
1SF	–	547.92.751	547.91.751	Soft focus filter
03D	–	547.92.756	547.91.756	Diffusion filter, mild soft focus
06D	–	547.92.757	547.91.757	Diffusion filter, medium soft focus
1D	–	547.92.752	547.91.752	Diffusion filter, strong soft focus
1F	–	547.92.753	547.91.753	Fog filter
44S	–	547.92.758	547.91.758	4-point star filter (4 mm ^{5/32} " thick)
46S	–	547.92.754	547.91.754	6-point star filter (4 mm ^{5/32} " thick)
48S	–	547.92.755	547.91.755	8-point star filter (6 mm ^{7/32} " thick)

* = See description on page 7-3

** = effective filter diameter: 110 mm (4^{3/8}")



Adapter Rings

For Thread	Ord. No (100 mm/4")	Ord. No (125 mm/5")	Remarks
M40.5 x 0.5	547.81.050	547.81.035 ♦	On older lenses it is best to measure the inner diameter of the mount at the front element with a ruler and add 1 mm. Example: Ø 66 mm → Adapter Ring M67 x 0.75). ♦ Can also be used with the Filter System 100 mm (4").
M49 x 0.75	547.81.051	547.81.036 ♦	
M52 x 0.75	547.81.052	547.81.037 ♦	
M55 x 0.75	547.81.060	547.81.044 ♦	
M58 x 0.75	547.81.053	547.81.038 ♦	
M62 x 0.75	547.81.054	547.81.047 ♦	
M67 x 0.75	547.81.055	547.81.039 ♦	
M72 x 0.75	547.81.061	547.81.045 ♦	
M77 x 0.75	547.81.056	547.81.040 ♦	
M82 x 0.75	547.81.057	547.81.041 ♦	
M85 x 0.75	547.81.062	547.81.046 ♦	
M86 x 1	547.81.058	547.81.042 ♦	
M95 x 1	–	547.81.043 ♦	
M100 x 1	–	547.81.019	
M105 x 1	–	547.81.020	
M110 x 1	–	547.81.021	
M112 x 1.5	–	547.81.024	
M120 x 1	–	547.81.022	
M127 x 1	–	547.81.023	
40.2 mm Ø	547.81.579	–	Slip-on adapter rings for attaching filters to the back of a lens. Ø 42, 60 and 80 mm resp.
60.2 mm Ø	547.81.587	–	
80.2 mm Ø	547.81.595	–	
Hasselblad 50	547.81.069	–	For Hasselblad Ø 50 bayonet ring For Hasselblad Ø 60 bayonet ring For Hasselblad Ø 70 bayonet ring For Rollei 70 mm filter thread.
Hasselblad 60	547.81.070	–	
Hasselblad 70	547.81.072	–	
Rollei	547.81.071	–	

GRADUATED FILTERS 125 mm (5")

547.91.900 – 999

Graduated Filters for the Sinar Color Control Filter System 125 mm (5"). Please see the "Graduated Filters" table for available colors and order numbers.

GRADUATED FILTERS 100 mm (4")

547.92.900 – 999

Graduated Filters for the Sinar Color Control Filter System 100 mm (4"). Please see the "Graduated Filters" table for available colors and order numbers.

Graduated Filters

Abbreviated Designation	Density	Order Number (100 mm/4")	Order Number (125 mm/5")	Color
Y.G.	0 – 0.6	547.92.903	547.91.903	Yellow Blue Chocolate Sepia Tabacco Violet Choral Sunset Twilight Pink Neutral Grey Neutral Grey Neutral Grey
B.G.	0 – 0.6	547.92.906	547.91.906	
Ch.G.	0 – 0.6	547.92.910	547.91.910	
S.G.	0 – 0.6	547.92.911	547.91.911	
T.G.	0 – 0.6	547.92.912	547.91.912	
V.G.	0 – 0.6	547.92.913	547.91.913	
C.G.	0 – 0.6	547.92.914	547.91.914	
Sunset	0 – 0.6	547.92.915	547.91.915	
Twilight	0 – 0.6	547.92.916	547.91.916	
P.G.	0 – 0.6	547.92.917	547.91.917	
3NDG	0 – 0.3	547.92.930	547.91.930	
6NDG	0 – 0.6	547.92.960	547.91.960	
9NDG	0 – 0.9	547.92.990	547.91.990	

Sinar Workshops

We consider our Imaging Education Center in Switzerland as an international platform for the dissemination and exchange of knowledge among photographers with an exciting variety of specialties. It gives us as members of the workshop team the opportunity to convey skills and experience in the field of large format photography with thorough competence.

Special Workshops

In this category we offer workshops conducted by renowned photographers describing their respective specialties, such as food photography, multiple exposures, masking techniques, and so forth. In order to keep the selection of topics interesting and up-to-date, we are constantly adding new applications of photography to our list of workshop subjects. Even though the emphasis is on creative aspects of photography, these workshops are also designed to transmit specific theoretical and practical know-how, thus creating stimulating new perspectives.

Workshops 1 and 2

Of course Sinar also offers workshops on camera technique itself, because we are convinced that mastering the large format camera is an extremely important prerequisite for making outstanding high-quality photographs. One of the courses is dedicated to the fundamentals of large format photography, making it suitable also for beginners in large format photography, including those who wish to have a non-committal hands-on look at a potential future working tool.



The other course is designed for professionals with considerable experience, who are interested in, for instance, mastering the control of contrast, or who wish to acquire a solid command of mixed sources of illumination, the close-up range and multiple exposures.



Professional Digital Photography

Workshops on digital photography are also on our regular workshop program. In a one-day course, we provide the basis for an individual assessment of its applicability to professionals from all phases of image and media production. Quality and economics of digital imaging are analyzed in relation to chemical photography. Practical demonstrations in the studio provide the basis for an evaluation of the possibilities of electronic photography.

Because proper handling of large format equipment cannot be learned by theory alone, our workshops emphasize the hands-on approach, using modern, well-equipped studios. By forming small working groups, we make sure that everyone has ample opportunities to handle the equipment. Everything you learn in these workshops is of practical value, even if you do not use a Sinar camera. We place great value on thorough course literature, because it helps you to reproduce the photographic demonstrations after the course and it also helps to apply the newly acquired skills to your own work.

You are most welcome to our workshops, regardless whether you are a professional or an amateur, an individual or part of a group. Upon request, we can organize courses at special rates for school groups. Please contact us. We will be pleased to send you our current course listings.

The Workshop Team

Sinar Books

Introduced by the Swiss publishing house PHOTOGRAPHIE in co-operation with Sinar, the series of books entitled "Creative Large Format" distinguishes itself by its high professional caliber.

The volumes published so far have already been awarded various prizes, including the

Kodak Photo Book Prize. Volume 1 on *Basics and Applications* constitutes the foundation for the entire series and should be on the reference shelf of every photographic studio.

Subsequent volumes on specific subjects refer to numbered sections of the respec-

tive chapters of that volume when general camera setting techniques are involved.

All titles are available in English, German and French. Volume 1 is also available in Spanish, Japanese, Chinese and Korean. Additional language versions are in preparation.

BASICS AND APPLICATIONS

Creative Large Format, Volume 1

05.0202

Everything you need to know about the prerequisites and the technical foundations of modern large format technique. The use of sharpness compensation and perspective correction in practical applications. A competent reference handbook for beginners and for professionals. 112 pages with more than 200 illustrations. Size: 22 x 28 cm (9 x 11").

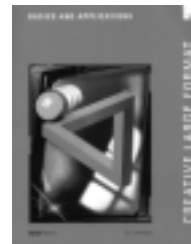

ARCHITECTURAL PHOTOGRAPHY

Creative Large Format, Volume 2

05.0302

This book conveys the essential know-how for necessary camera adjustments, choice of camera position and focal length, picture composition, as well as advance planning of architectural photographs. A portfolio section backs up theory with numerous large-format practical examples with detailed explanations. 88 pages with more than 70 illustrations. Size: 22 x 28 cm (9 x 11").

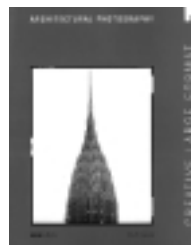

NATURAL LANDSCAPES

Creative Large Format, Volume 3

05.0402

Even today, only large format photography can reproduce the details, structures, colors and moods of natural landscapes without losses. The competent sections on technique and creativity is beautifully supplemented by numerous elegantly presented pictorial examples by accomplished large format photographers. 88 pages with more than 70 illustrations. Size: 28 x 22 cm (11 x 9").



PEOPLE PHOTOGRAPHY

Creative Large Format, Volume 4

05.0502

People photography is trendy. With the help of examples and sketches all aspects of people photography are explained going from camera size, through lighting up to copyrights. First-class portfolios with pictures of internationally renowned photographers stimulate your creativity. 96 pages with more than 100 illustrations. Size: 22 x 28 cm (9 x 11").

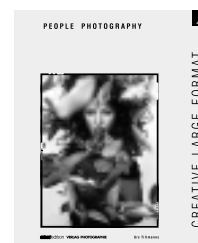

ADVERTISING PHOTOGRAPHY

Creative Large Format, Volume 5

05.0602

In today's tidal flood of images, the aim of advertising photography is to attract attention to itself. This book demonstrates how dramatic effects can be achieved with the adjustable view camera. Internationally successful advertising photographers explain how they create their campaigns. 88 pages with more than 100 illustrations. Size: 22 x 28 cm (9 x 11").



Sinar Boutique

07.0400 **Gilden Pen**



07.0300 **Silvered Pen**



07.1500 **Black Pen**



07.0910 **RGB Pen**



07.0600 **Swiss Army Knife**



07.0601 **Mini pocket knife**



07.0602 **SwissCard
pocket knife**



07.0603 **Cyber Tool**



07.2700 **Pin Sinar gold 18K**



07.2720 **Pin Sinar Label**



07.2750 **Earring gold 18K**



07.3800 **Sinar Lighter**



07.0200 **Sinar Cork-screw**



07.3500 **Sinar Umbrella**



07.1300 **Sinar Sticker**



07.2021 **Sinar Poloshirt M**
07.2031 **Sinar Poloshirt L**
07.2041 **Sinar Poloshirt XL**



07.2500 **Sinar Overall**



07.2100 **Sinar City Bag**



07.3200 **Sinar plastic bag**



08.1202 **Documentation
Sleeve**



07.3900 **Sinar Conference
Folder**



07.1200 **Sinar Mouse Pad**



www.sinarcameras.com



Sinar can be found on the internet under www.sinarcameras.com. Our website features product information as well as information about cultural matters, additional training, and online shopping. It has the following interesting categories:

- News:** Here you can find the very latest information about the Sinar company and its products.
- Seminar:** This category uses the format of a short seminar to present all the advantages of the Sinar view camera system.
- Calendar:** Every year Sinar produces its own calendar, which has become a collector's item. Photographs used in the current calendar and instructions for submitting pictures for the next calendar are shown in this category.
- Books:** The "Creative Large Format" series of books published by the PHOTOGRAPHIE publishing house in cooperation with Sinar distinguishes itself by its refined professionalism. This category describes the individual books in this series and it furnishes information for ordering the books directly via the internet.
- Distributors:** Our representatives in your country, carefully selected by Sinar, have specialists on staff who can expertly counsel you in your own language. This category lists the local Sinar agencies in your country.
- Support:** This category is intended for professional support of Sinar specialists on site. A password is required for accessing this category.
- CaptureShop:** Sinar CaptureShop™ is the software for the "Sinarback", the proprietary Sinar digital back. Because it has great versatility and high-perfor-

mance software, Sinar offers you, the user, the opportunity of obtaining the desired information right from the source.

- Cameras:** Here you can find relevant information about current models of Sinar cameras and about the extensive range of accessories in the Sinar building block system.
- Digital:** If you are looking for specific information about Sinar digital products, this is the right place: Digital cameras, digital backs, digital accessories as well as camera configurations are described in this category.
- Workshops:** Would you like to learn the secrets of large format photography? Do you have the need for acquiring expertise in digital imaging? If so, this is precisely the right place! Information about specialized workshops for all needs – this chapter lists current dates and conditions of participation.
- Gallery:** The Sinar Gallery presents a selection of outstanding images that have graciously been made available by talented Sinar photographers from around the world.
- Feedback:** This is a forum that offers you the opportunity of sharing some of your experiences in using our products.
- Shop:** Our era of modern communication makes it delightfully convenient to order products via the internet. The Sinar Shop continuously offers well-maintained and fully functional camera accessories and occasionally even complete cameras from our stock of demonstration equipment. The selection is constantly being updated. We encourage you to check it out sometime!

Sinar Agencies

ARGENTINA

Optica Cosentino S.A.C.I.
Avda. Presidente Roque Sáenz Peña 738
AR-1035 Buenos Aires
Tel.: (+54)11 4 328 91 20
Fax: (+54)11 4 328 91 23
E-mail: info@cosentino.to
Website: www.cosentino.to

AUSTRALIA

Baltronics Pty. Ltd.
3 Northcliff Street, Suite B
AU-Millsons Point, NSW 2061
Tel.: (+61)2-99 59 52 00
Fax: (+61)2-99 22 78 77
E-mail: baltronics@bigpond.com

AUSTRIA

Slach Bildtechnik
Vertriebsges. mbH & Co. KG
Kolpingstrasse 21
Postfach 61
AT-1232 Wien
Tel.: (+43)1-61 04 40
Fax: (+43)1-610 44 50
E-mail: info@slach.at

BAHRAIN

Image Masters Centre
P.O.Box 40056
BH-Manama
Tel.: (+973)24 33 48
Fax: (+973)25 04 05
E-mail: ally@greenmail.net

BELGIUM

EMDAY Graphic SA
Avenue Cogen 77
BE-1180 Bruxelles
Tel.: (+32)2-348 49 80
Fax: (+32)2-348 49 99
E-mail: marc.depauw@village.uunet.be

BELGIUM / LUXEMBOURG

Paul Hotz S.A.
Rue de la Gare 3
Stationsstraat
BE-1040 Bruxelles
Tel.: (+32)2-734 34 01
Fax: (+32)2-733 35 84
E-mail: arul@hotz.be
Website: www.hotz.be

BRAZIL

Importécnica S.A.
Rua Baronesa de Porto Carreiro 352
BR-01133-010 São Paulo
Tel.: (+55)11-36 62 42 91
Fax: (+55)11-36 67 11 61
E-mail: importec@wm.com.br

BULGARIA

Zhivas Co. Ltd.
36, Dondoukov Blvd.
BG-1000 Sofia
Tel.: (+359)2-981 78 23
Fax: (+359)2-981 78 23
E-mail: zhivko@mail.techno-link.com

CANADA

AMPLIS Foto Inc.
22 Telson Road
CA-Markham, Ontario L3R 1E5
Tel.: (+1)905-477 4111
Fax: (+1)905-477 2502
E-mail: amplis@planeteer.com

CHILE

Servicios Fotográficos Ltda.
Perez Valenzuela 1503
CL-Santiago
Tel.: (+56)2-235 78 70
Fax: (+56)2-235 90 41

COLOMBIA

Sofocol Ltda.
Calle 45 No. 8 - 32
Apartado Postal
CO-Bogotá 2
Tel.: (+57)1-338 49 55
Fax: (+57)1-338 23 84

CROATIA

Ilijic D.O.O.
Gor. Prekrižje 23
HR-41000 Zagreb
Tel.: (+385)1-467 34 95
Fax: (+385)1-467 34 95
E-mail: ilijic@ibm.net
Website: www.lavsa.com/ilijic

CZECH REPUBLIC / SLOVAKIA

Profifoto s.r.o.
Veverkova 28
CZ-17000 Praha 7
Tel.: (+420)2-33 37 29 85
Fax: (+420)2-33 37 03 04
E-mail: profifoto@anet.cz
Website: www.profifoto.cz

DENMARK

Hother Import ApS
Palaegade 5
DK-1261 Copenhagen K
Tel.: (+45)33 93 13 97
Fax: (+45)33 93 13 96
E-mail: hother@ibm.net
Website: www.ejulhother.dk

FINLAND

Eiri Oy
Teollisuuskatu 29
P.O. Box 73
FI-00510 Helsinki
Tel.: (+358)9-229 19 41
Fax: (+358)9-22 91 93 11
E-mail: osmo.kiiskinen@eiri.fi
Website: www.eiri.fi

FRANCE

Photo Service July
73, rue Albert Dhalenne
B.P. 109
FR-93403 Saint-Ouen Cedex
Tel.: (+33)1-40 11 24 36
Fax: (+33)1-40 11 82 57
E-mail: info@photo-service-july.fr

GERMANY

PSL Photosysteme GmbH
Kurt-Fischer-Strasse 25
Postfach 1531
DE-22905 Ahrensburg
Tel.: (+49)41-02 46 40
Fax: (+49)41-02 4 45 67
E-mail: psl.photosysteme@t-online.de
Website: www.pslphotosysteme.de

GREAT BRITAIN

Silicon Imaging Ltd.
45 Millharbour
GB-London E14 9TR
Tel.: (+44)20-7538 1010
Fax: (+44)20-7537 1675
E-mail: mark.middlebrook@silicon-imaging.co.uk

GREAT BRITAIN

The Studio Workshop
20/22 Brunswick Centre
Bernard Street
GB-London WC1N 1AE
Tel.: (+44)20-7278 7633
Fax: (+44)20-7278 7340
E-mail: office@tsw-lon.demon.co.uk

GREECE

Interfoto
P.O.Box 52 891
N. Erythrea
GR-146 01 Athens
Tel.: (+30)1-752 58 10
Fax: (+30)1-752 58 10
E-mail: interfot@otenet.gr
Website: www.interfoto.gr

HONG KONG / CHINA

Schmidt Photo
9/F, North Somerset House
Taikoo Place, 979 King's Road
HK-Quarry Bay
Tel.: (+852)25 07 03 33
Fax: (+852)29 68 06 82
E-mail: jackiechan@shk.schmidtgroup.com
Website: www.shk.schmidtgroup.com

HUNGARY

Artfoto (Flair Mode Kft.)
Moszkva tér 10
HU-1024 Budapest
Tel.: (+36)1-316 02 67
Fax: (+36)1-316 02 67
E-mail: info@artfoto.hu
Website: www.datanet.hu/artfoto

INDIA

Foto Fantasia
3 Shirish Duplexes
Prabhat Rd., Lane no.11, Erandwana
IN-Pune 411 004
Tel.: (+91)212-37 30 11
Fax: (+91)212-37 37 38
E-mail: fotofantasia@vsnl.com

INDONESIA

Primacolor
44 CD Hasyim Ashari
ID-Jakarta 10140
Tel.: (+62)21-634 31 27
Fax: (+62)21-634 22 71
E-mail: pci@jakarta.wasantara.net.id

IRAN

Aphomar Co. Ltd.
127, South Sohrevardi Ave.
P.O. Box 11365/1167
IR-Tehran
Tel.: (+98)21-875 21 62
Fax: (+98)21-873 91 09
E-mail: aphomar@tavana.net

IRELAND

DML
Data Micrographics Ltd.
Portobello Harbour
IE-Dublin 8
Tel.: (+353)1-478 18 88
Fax: (+353)1-478 18 50
E-mail: dml@indigo.ie

ISRAEL

Hadar Photo Supply
Agencies Ltd.
36-38 Achad Haam St.
P.O.Box 1686
IL-Tel-Aviv 61016
Tel.: (+972)3-560 39 47
Fax: (+972)3-560 39 05
E-mail: hadarpht@netvision.net.il

ITALY

Mafer S.r.l.
Via G.B. Brocchi, 22
IT-20131 Milano
Tel.: (+39)02-70 63 87 26
Fax: (+39)02-236 79 77
E-mail: mafer@maferfoto.it
Website: www.maferfoto.it

JAPAN

Nihon Siber Hegner K.K.
Siber Hegner Mita Building
3-4-19 Mita, Minato-Ku
JP-Tokyo 108
Tel.: (+81)3-54 41 45 66
Fax: (+81)3-54 41 45 24
E-mail: alex.russell@siberhegner.com

LEBANON

Gulbenk Corporation
Jal el Dib Highway 421
P.O. Box 11-3111
LB-Beirut
Tel.: (+961)4-41 42 38
Fax: (+961)4-71 78 00

MALAYSIA

King's Photo
158-2-6, Kompleks Maluri
Jalan Jejaka, Taman Maluri
MY-55100 Kuala Lumpur
Tel.: (+60)3-9200 34 19
Fax: (+60)3-9200 36 71
E-mail: contacts@kingsphoto.com.my
Website: www.kingsphoto.com

MEXICO

Comercial Suizo
Mexicana S.A. de C.V.
Av. Revolucion 1884 - 102 C.P.
Apdo. Postal 20-197
MX-01000 Mexico, D.F.
Tel.: (+52)5-550 28 59
Fax: (+52)5-550 41 68
E-mail: aleyva@starnet.net.mx

NETHERLANDS

Photal fototechnische
Handelsonderneming
Edisonstraat 31
Postbus 61
NL-6600 AB Wijchen
Tel.: (+31)24-642 03 34
Fax: (+31)24-642 14 53
E-mail: info@photal.nl
Website: www.photal.nl

NEW ZEALAND

APIX
4-6 Dundonald Street
NZ-Newton, Auckland
Tel.: (+64)9 307 31 77
Fax: (+64) 9 307 31 12
E-mail: alistair@apix.co.nz

NORWAY

Lars Farnes A/S
Pottemakerveien 8
Postbox 34, Kalbakken
NO-0901 Oslo 9
Tel.: (+47)22 16 29 30
Fax: (+47)22 16 47 39
E-mail: farnes.as@online.no

OMAN

Photocentre LLC
Off Wadi bin Arabee Habib Street,
Wadi Al-Kabir
P.O. Box 115
OM-Ruwi 112
Tel.: (+968)771 47 52
Fax: (+968)771 12 54

PHILIPPINES

Island Multi-Industrial
Sales Corp.
108 Gamboa St., Legaspi Village
Makati CP0 Box 3346
PH-Makati, Metro Manila
Tel.: (+63)2-818 17 88
Fax: (+63)2-810 55 23
E-mail: islandm@i-next.net

POLAND

Dicam s.c.
Profesjonalny Sprzet Fotograficzny
ul. Burakowska 5/7
PL-01-066 Warszawa
Tel.: (+48)22-838 87 33 od.
(+48)22 636 12 73
Fax: (+48)22-838 87 33
E-mail: arygier@polbox.com

PORTUGAL

Imporfoto Lda.
Rua do Açúcar, 42
PT-1900 Lisboa
Tel.: (+351)21-862 13 00
Fax: (+351)21-868 73 59
E-mail: infor@imporfoto.pt
Website: www.imporfoto.pt

ROMANIA

Focus Trading 94 srl
Sos. Stefan cel Mare, 15
Sc. C Ap.25 Sector 2
RO-72132 Bucuresti
Tel.: (+401) 679 75 83
Fax: (+401) 230 01 07
E-mail: focus94@fx.ro

RUSSIA

ul. B. Potchtovaya 18/20
Korps. 3, Kv. 91
RU-Moscow 107 082
Tel.: (+7)095-265 39 89
Fax: (+7)095-265 39 89
E-mail: loginov@caravan.ru

SAUDI ARABIA

Murad Photo Imaging
Khurais Road, Al Nahda
P.O. Box 8482
SA-Riyadh 11482
Tel.: (+966)1-231 09 76
Fax: (+966)1-231 10 44

SINGAPORE

Prima Studio Equipment Pte Ltd.
50 Kallang Pudding Road #05-01B
Golden Wheel Industrial Building
SG-Singapore 349326
Tel.: (+65)844 10 89
Fax: (+65)841 52 67
E-mail: alanyong@mbox4.singnet.com.sg

SOUTH AFRICA

Fotoquip Bestinvest CC
Lower Suite, Whitecliffs, 5 Dover St.
P.O.Box 3712
ZA-Randburg, 2125
Tel.: (+27)11-886 40 37
Fax: (+27)11-787 20 30
E-mail: info@fotoquip.co.za
Website: www.fotoquip.co.za

SOUTH KOREA

Saeki Panme Co., Ltd.
Rm 301 Saeki Bldg,
143 Waryoung-Dong,
Jongro-Ku, K.P.O. Box 1822
KR-Seoul
Tel.: (+82)2-764 19 14
Fax: (+82)2-742 33 87
E-mail: m.h.lee@saeki.co.kr
Website: www.saeki.co.kr

SPAIN

Ingrafic
Pl. Alqueria Nova
8 bajo
ES-46014 Valencia
Tel.: (+34)-96-350 08 66
Fax: (+34)-96-350 09 32
E-mail: ingrafic@ingrafic.com
Website: www.ingrafic.com

SWEDEN

Molander & Son AB
Ekholmsvägen 36
Box 19
SE-12721 Skärholmen
Tel.: (+46)8-680 15 70
Fax: (+46)8-740 66 74
E-mail: info@molanders.se
Website: www.molanders.se

SWITZERLAND

Sinar Imaging Center
Rieterstrasse 80
CH-8002 ZürichS
Tel.: (+41)1 280 27 27
Fax: (+41)1 280 35 35
E-mail: info@sic-imaging.ch
Website: www.sic-imaging.ch

TAIWAN R.O.C.

Lunar International Co., Ltd.
Office 244, Sec. 2
Keelung Road
TW-Taipei
Tel.: (+886) -22-736 42 31
Fax: (+886) -22-732 31 43
E-mail: info@lunar.com.tw
Website: www.lunar.com.tw

THAILAND

Krung Siam Enterprise Co., Ltd.
No. 808, Rachisima Road
Thanonnakornchaisri, Dusit
TH-Bangkok 10300
Tel.: (+66)2-669 5425-9
Fax: (+66)2-669 5424
E-mail: kseco@ksc15.th.com

TURKEY

Darfilm A.S.
Yeniçarsi Cad. No. 40
Galatasaray
TR-80050 Istanbul
Tel.: (+90)212-293 75 00
Fax: (+90)212-293 78 94
E-mail: tech@darfilm.com.tr
Website: www.darfilm.com.tr

UNITED ARAB EMIRATES

Salam Studio & Stores L.L.C.
Wafi Shopping Mall
P.O. Box 4199
AE-Dubai
Tel.: (+971)4-324 52 52
Fax: (+971)4-324 61 10
E-mail: dawood@salam.co.ae

USA

Sinar Bron Imaging
17 Progress Street
US-Edison, N.J. 08820
Tel.: (+1)908-754 58 00
Fax: (+1)908-754 58 07
E-mail: info@sinarbron.com
Website: www.sinarbron.com

VENEZUELA

Elinchrom Venezolana S.A.
4ta. Av. de Campo Alegre, 24
Villa Arenas
VE-Chacao-Caracas 1060-A
Tel.: (+58)2-266 19 12
Fax: (+58)2-266 23 61
E-mail: evsa@link7.lat.net

